

What Limits Working Memory Capacity?

Klaus Oberauer
University of Zurich

Simon Farrell
University of Western Australia and University of Bristol

Christopher Jarrold
University of Bristol

Stephan Lewandowsky
University of Bristol and University of Western Australia

We review the evidence for the 3 principal theoretical contenders that vie to explain why and how working memory (WM) capacity is limited. We examine the possibility that capacity limitations arise from temporal decay; we examine whether they might reflect a limitation in cognitive resources; and we ask whether capacity might be limited because of mutual interference of representations in WM. We evaluate each hypothesis against a common set of findings reflecting the capacity limit: The set-size effect and its modulation by domain-specificity and heterogeneity of the memory set; the effects of unfilled retention intervals and of distractor processing in the retention interval; and the pattern of correlates of WM tests. We conclude that—at least for verbal memoranda—a decay explanation is untenable. A resource-based view remains tenable but has difficulty accommodating several findings. The interference approach has its own set of difficulties but accounts best for the set of findings, and therefore, appears to present the most promising approach for future development.

Keywords: working memory, capacity limits, decay, resources, interference

Working memory (WM) is the system that holds mental representations available for processing. Its limited capacity is a limiting factor for the complexity of our thoughts (Halford, Cowan, & Andrews, 2007; Oberauer, 2009). Measures of WM capacity have been identified as major determinants of cognitive development in childhood (Bayliss, Jarrold, Gunn, & Baddeley, 2003) and in old age (Park et al., 2002; Salthouse, 1994), as well as of individual differences in intellectual abilities (Conway, Kane, & Engle, 2003; Jarrold & Towse, 2006). Understanding why WM capacity is limited is, therefore, an essential step toward understanding why human cognitive abilities are limited, why individuals differ in these abilities, and how abilities develop over the life span.

In this article we use the term *WM capacity* in a descriptive sense, referring to the fact that people can hold only a limited amount of mental content available for processing. The capacity limit is usually operationalized as a limit on how much new

information people can remember over short periods of time (in the order of seconds), but there are reasons to believe (discussed below) that the capacity limit also applies to people's ability to make information in the current environment simultaneously available for processing.

Hypotheses about what limits WM capacity can be organized into three groups: (a) Some theories assume that representations in WM *decay* over time, unless decay is prevented by some form of restoration process such as rehearsal. According to this view, WM has limited capacity because only a limited amount of information can be rehearsed before it fades away into an irrecoverable state (Baddeley, Thomson, & Buchanan, 1975; Schweickert & Boruff, 1986). (b) Alternatively, WM capacity has been characterized as a limited *resource* that needs to be shared by representations held available simultaneously and processes to be carried out at the same time (Case, Kurland, & Goldberg, 1982; Just & Carpenter, 1992; Ma, Husain, & Bays, 2014). This resource could be continuous or discrete, and the discrete variant is often referred to as a "slot model" (Cowan, Rouder, Blume, & Saults, 2012). (c) A third approach is to explain the limited capacity of WM as arising from *interference* between representations that do not decay on their own and are not resource-limited (Nairne, 1990; Oberauer & Kliegl, 2006; Saito & Miyake, 2004).

After over 50 years of research on this topic, experimental psychologists have accrued a large and detailed database of relevant studies. Perhaps unsurprisingly, the existing data do not appear to universally support any one of the three accounts of WM capacity. Given this state of affairs, it is useful to step back and ask how well each of the three explanatory approaches outlined above accord with the data, and which data are particularly diagnostic. The aim of the present article is to evaluate critically the explan-

This article was published Online First March 7, 2016.

Klaus Oberauer, Department of Psychology–Cognitive Psychology, University of Zurich; Simon Farrell, School of Psychology, University of Western Australia and School of Experimental Psychology, University of Bristol; Christopher Jarrold, School of Experimental Psychology, University of Bristol; Stephan Lewandowsky, School of Psychology, University of Western Australia and School of Experimental Psychology, University of Bristol.

The research reported in this article was supported by a grant from the Swiss National Science Foundation (100014_135002) to Klaus Oberauer.

Correspondence concerning this article should be addressed to Klaus Oberauer, University of Zurich, Department of Psychology–Cognitive Psychology, Binzmühlestrasse 14/22, 8050 Zürich, Switzerland. E-mail: k.oberauer@psychologie.uzh.ch

atory power of these three hypotheses in light of a common set of findings pertinent to the capacity limit of WM.

Terms of the Competition: Analytical Approach

Our review focuses primarily on evaluating each hypothesis on its own as an explanation of the capacity limit of WM, for two reasons. First, explanations by a single hypothesized mechanism or process are preferable over multicausal explanations because they are more parsimonious. Second, analyzing each hypothesis in isolation enables us to identify which empirical findings can be explained by that hypothesis on its own, and which findings challenge it. This analytical approach will be informative even for theories that combine multiple causes of the capacity limit. Toward the end of this article we will, therefore, consider the potential for combining different mechanisms to move toward a complete model of WM capacity.

Evaluating hypotheses in isolation is potentially hazardous because the predictions following from each hypothesis depend on other assumptions with which they are combined in a theory or model (Newell, 1973). This problem can be circumvented by evaluating each hypothesis about what underlies the WM capacity limit in the context of a fully fleshed-out computational model of WM. In our review we draw on computational models incorporating the hypothesis in question where possible. At the same time this approach engenders another limitation: Evaluating a hypothesis in the context of a particular theory or model can only determine to what extent the conjunction of all assumptions in the model is able to explain certain findings; it is difficult to attribute the empirical success or failure of a model to one hypothesis incorporated in that model. For instance, if one interference model fails to explain an important phenomenon, proponents of an interference explanation of WM capacity can always argue that the interference hypothesis might work better in the context of another model. As the number of possible models incorporating an assumption is potentially infinite, empirically ruling out individual

models can never rule out the entire set of possible models incorporating a particular hypothesis.

In light of these considerations our approach in this review is the following: We try to identify, for each of the three hypotheses under investigation, predictions that follow from it in the context of all existing theories or models that incorporate that hypothesis as the main cause of the WM capacity limit. Table 1 provides an overview of the theories we used as context to determine the predictions of each hypothesis. We selected these theories because they explain the WM capacity limit fairly unambiguously according to only one of the three hypotheses under investigation; this excludes many theories that draw on a combination of hypotheses, or that make no unambiguous assumptions as to what causes the WM capacity limit. Where we find that a prediction derived from a hypothesis in the context of all theories in Table 1 is borne out by the data we regard the evidence as strongly supporting the hypothesis. Conversely, where we find that a prediction is not supported empirically, we regard that as a challenge to proponents of the hypothesis: Although it remains possible that the hypothesis, when put in the context of a new model, meets that challenge, we argue that the burden of proof then lies with the proponents of that hypothesis to present such a model.

In addition, we ask whether the hypothesis, in conjunction with additional assumptions that are made by some but not all theories incorporating that hypothesis, can explain a given finding. Where that is the case, the finding provides support for the hypothesis, but the support is weaker than in cases where the hypothesis predicts the finding, because the explanation depends on additional assumptions that are made only by some theories incorporating the hypothesis. To summarize, our evaluation of each hypothesis with respect to each finding aims to determine which of four logical relations holds between the hypothesis and the finding: (a) The finding is *predicted* by one of the hypotheses, meaning that it follows from the hypothesis without any additional assumptions that are not shared by all known theories incorporating the hypoth-

Table 1
Theories Used as Context to Derive Predictions From Hypotheses

Decay	Resources	Interference
Phonological-loop model (Baddeley et al., 1975; Schweickert & Boruff, 1986)	Neo-Piagetian general resource model (Case et al., 1982)	Feature model (Nairne, 1990)
Limited-capacity trace-decay theory (Jensen, 1988; Salthouse, 1996)	Multiple-resource model (Alloway et al., 2006; Logie, 2011)	Interference model (Oberauer & Kliegl, 2001, 2006)
Primacy model (Page & Norris, 1998)	3CAPS (Just & Carpenter, 1992)	SOB (Lewandowsky & Farrell, 2008b) and SOB-CS (Oberauer, Lewandowsky, et al., 2012)
Task-switching model (Towse & Hitch, 1995; Towse, Hitch, & Hutton, 2000)	Slot model (Luck & Vogel, 2013; Cowan et al., 2012)	Temporal-clustering-and-sequencing model (Farrell, 2012)
Computational phonological loop model (Burgess & Hitch, 1999, 2006)	Resource models of visual WM (Ma et al., 2014)	
Time-based resource-sharing model (Barrouillet et al., 2004; Camos et al., 2009)		

Note. Theories in the table were selected because they attribute the working memory (WM) capacity limit unambiguously to decay, limited resources, or interference, respectively. Some theories of WM were not included because they combine two or three of the hypotheses, or make no clear assumptions about what causes the capacity limit. We regard the time-based resource-sharing model as a decay model because, unlike resource models, it assumes that decay is the root cause of the capacity limit of WM, and an attentional resource is assumed to play a role only insofar as it counteracts decay (through refreshing). Without decay, there would be no role for a resource in that model.

esis; (b) the finding *can be explained* by one of the hypotheses, meaning that the finding is predicted by the hypothesis together with additional assumption that have been proposed in an existing theory, or that can reasonably be made; (c) the finding *challenges* one of the hypotheses, meaning that the hypothesis, in the context of any known theory, predicts the absence of the finding, and (d) the finding is *consistent* with the hypothesis, meaning that the finding provides no evidence in favor or against the hypothesis.

The Playing Field: Findings for Evaluating Hypotheses About WM Capacity

We evaluate all three hypotheses against a set of findings that we regard as informative for our question, based on the conjunction of two criteria: relevance and diagnosticity. We use the first criterion, *relevance*, to delimit a set of phenomena that are generally agreed among researchers to be manifestations of the capacity limit of WM. We use the second criterion, *diagnosticity*, to select findings within the set of relevant phenomena that count as evidence in favor or against at least one of the three hypotheses under investigation. Specifically, we regard as diagnostic any finding that stands in one of three logical relations (out of the four defined above, excluding consistency) to at least one of these hypotheses: The hypothesis *predicts* the finding, it *can explain* the finding, or it is *challenged by* the finding.

Relevant Phenomena

Concerning the first criterion—relevance—we consider three broad phenomena as manifestations of the WM capacity limit: (a) The set-size effect on accuracy, (b) the effects on memory of manipulations of the retention interval and the events during that interval, and (c) the pattern of correlations among tests thought to measure WM capacity and related cognitive tasks. Each of those three phenomena, in turn, is characterized by a number of findings that specify the precise nature of the phenomenon. Every viable theory of WM capacity must explain these three phenomena, including the detailed findings characterizing them. The informative findings we include in this review are the findings that reflect aspects of these three phenomena, and at the same time are diagnostic for the three hypotheses.

We next briefly introduce each phenomenon, together with our reasons for selecting it. Our review will be organized by these three broad phenomena. In each section, we explain how each of the three hypotheses accounts for the phenomenon reviewed in it. In doing so we will spell out the predictions following from each hypothesis, the diagnostic findings speaking to these predictions, and the additional assumptions by which each hypothesis needs to be embellished to explain specific findings. Tables 2 to 4 provide an overview of these findings, together with our assessment of their logical relation to each of the three hypotheses. In what follows we will cross-link discussion of each finding in the text with the corresponding entries in Tables 2 to 4 using letters to refer to the three broad phenomena, and numbers to refer to individual findings characterizing the phenomenon in question.

A: Set-size effects. As the amount of material a person tries to hold in WM increases, memory accuracy decreases. For instance, people find it increasingly more difficult to remember a list of digits or words for immediate serial recall as the list gets longer,

and their short-term memory (STM) for visual objects declines with an increasing number of objects to be remembered (Luck & Vogel, 1997; Miller, 1956). This ubiquitous observation has been referred to as the effect of memory set size or of memory load. It is a direct reflection of the WM capacity limit: The concept of limited WM capacity implies that performance gets worse as the amount of information to be held in WM is increased and eventually surpasses that limit. Therefore, any explanation of WM capacity must explain the set-size effect.

B: Effects of retention interval and distractor processing. Representations in WM are vulnerable to processing during a retention interval (RI) placed between study and test, which can lead to forgetting in the order of seconds. Experimental control over cognitive processes during the RI is often achieved by asking people to engage in a specific processing task—such as counting, mental arithmetic, or reading aloud—while maintaining a memory set. We will refer to these processing demands as *distractor tasks*. Distractor tasks have been placed after presentation of the entire memory set, as in the Brown-Peterson paradigm (J. Brown, 1958; Jarrold, Tam, Baddeley, & Harvey, 2011; Peterson & Peterson, 1959), interleaved with presentation of individual items, as in the complex-span paradigm (Daneman & Carpenter, 1980; Turner & Engle, 1989), or interleaved with recall of individual items (Lewandowsky, Duncan, & Brown, 2004; Lewandowsky, Geiger, & Oberauer, 2008). Distractor processing during the RI typically has a detrimental effect on memory accuracy. There is general agreement that this detrimental effect reflects the limited capacity of WM, because the processing demand is thought to place an additional load on this capacity, thereby reducing the effective capacity available for holding the memory set. Therefore, we regard the effects of distractor processing during the RI as a phenomenon that every viable explanation of the WM capacity must account for. In this context we will also discuss findings on the effect of varying the duration of an “unfilled” RI, that is, an interval between study and test during which mental activity is not experimentally controlled, because some of these findings are diagnostic with regard to the three hypotheses.

C: Individual differences. A viable explanation of WM capacity should also explain, or at least be consistent with, findings concerning individual differences—including age differences—in WM capacity (Conway, Jarrold, Kane, Miyake, & Towse, 2007), because much of the evidence for a capacity limit applying broadly to all kinds of complex cognition arises from that research. In particular, correlational data show that the WM capacity limit has a high degree of generality across contents and testing procedures (Kane et al., 2004; Oberauer, Süß, Schulze, Wilhelm, & Wittmann, 2000; Unsworth, Fukuda, Awh, & Vogel, 2014). If different measures of WM capacity limits were only weakly correlated, the very idea of a singular WM capacity would be questionable. In addition, correlational data are informative because—as we will explain below—different hypotheses about WM capacity make different predictions about which other variables are correlated with measures of WM capacity.

On the Choice of Informative Findings

A comparative evaluation of hypotheses against data in a field as broad as WM capacity is necessarily selective. By making the

reasons for our selection of data explicit we tried to rein in to some extent the arbitrariness and potential bias involved in prioritizing some pieces of evidence over others. We identified three basic phenomena that are commonly regarded as direct expressions of the capacity limit of WM, and we argue that every successful explanation of the WM capacity limit must explain these phenomena. A viable explanation of these basic phenomena must be in agreement with the empirical details known about them, and therefore, we consider the research characterizing set-size effects, effects of distractor processing during the RI, and correlational findings in some detail.

At the same time, we exclude from consideration a vast number of well-established empirical findings about WM, such as the effects of serial position in memory for lists (Nipher, 1878), the effects of presentation rate and presentation modality (Penney, 1975), the effects of irrelevant sounds on verbal serial-order memory (Jones & Macken, 1993), or the effects of cueing attention to an item within WM (Lepsien & Nobre, 2006). These and many other findings are highly informative about the mechanisms of WM, but they do not speak as directly to the capacity limit of WM as the three phenomena introduced above, because they are not generally agreed to be direct manifestations of the capacity limit. For the same reason we excluded the set-size effect on response times (Lange, Cerella, & Verhaeghen, 2011; Sternberg, 1966): Whereas the increasing time for access to WM contents with increasing set size could reflect the capacity limit of WM, it could equally reflect the longer duration of search through a larger set, independent of the capacity limit. Hence, unlike the set-size effect on accuracy, the set-size effect on response times is not unambiguously a manifestation of the WM capacity limit.

We also excluded from consideration several findings that belong to one of the three broad phenomena we identified above, but that are not diagnostic. For instance, the finding that distractor processing impairs memory for individual visual features as much as memory for feature bindings (Allen, Baddeley, & Hitch, 2006; Morey & Bieler, 2013) is an instance of the effect of distractor processing on memory. Yet, this finding does not help to adjudicate between the three hypotheses under consideration, because none of them implies that the WM capacity limit should or should not apply equally to features and to bindings. Likewise, the strong correlation of WM capacity with fluid intelligence (Conway et al., 2003) is perhaps the one correlational finding about WM that has received more attention than any other, but it is not diagnostic, because all three hypotheses explain it in essentially the same way: Reasoning ability is limited by the amount of task-relevant information that we can hold in WM at the same time, and the details of this explanation have more to do with our assumptions about reasoning than with our assumptions about why WM capacity is limited.

Finally, we limit the scope of our empirical review to behavioral data from healthy individuals, excluding data from special populations with certain pathologies or neurological damage, as well as data from neuroscience. Whereas these data are highly informative about the mechanisms of WM, we found them not to be diagnostic for adjudicating between the three hypotheses about the nature of the WM capacity limit, because the hypotheses do not make differential predictions for these kinds of data.

In short, our selection of evidence for this review does not reflect a judgment of the importance of a set of findings for WM research in general. Rather, it reflects the relevance of findings for the specific question we ask: How best to explain the limited capacity of WM?

Although we have endeavored to be explicit about the reasons for our selection, and impartial in the choice of findings included, we expect that our choice of informative findings will be questioned by some. We hope that this will initiate a debate about which findings should be regarded as benchmarks for evaluating the hypotheses under consideration—in other words: What needs to be explained by a viable explanation of the WM capacity limit?

The Contenders: Three Hypotheses About What Limits WM Capacity

We start the competition with an introduction of the three hypotheses under consideration. After that we will evaluate each of them in light of diagnostic findings, organized by the three broad phenomena outlined above.

Decay

The first hypothesis we investigate is that WM capacity is limited by the rapid decay of WM representations over time. Theories assigning an important role to decay invariably assume that decay can be counteracted by one or several forms of restoration. Earlier research focused primarily on subvocal articulation as a process for maintaining verbal representations in WM (Baddeley et al., 1975). A domain-specific rehearsal mechanism based on the spatial orientation of attention might also be available for maintaining spatial information (Awh, Jonides, & Reuter-Lorenz, 1998; but see Belopolsky & Theeuwes, 2009).

More recently, proponents of decay introduced the assumption that verbal memoranda can be maintained by at least two processes; subvocal articulation and attention-based refreshing (Camos, Lagner, & Barrouillet, 2009).¹ Refreshing is conceptualized as a domain-general process of strengthening memory traces by directing central attention to them (Barrouillet, Bernardin, Portrat, Vergauwe, & Camos, 2007; Raye, Johnson, Mitchell, Greene, & Johnson, 2007). Central attention is thought to be limited to one process at a time, thereby creating a bottleneck (Pashler, 1994): Central attention can be devoted to refreshing only during time intervals in which it is not recruited by another cognitive process. One implication of this assumption is that refreshing, like articulatory rehearsal, has to proceed sequentially, strengthening one memory item at a time. On these assumptions the capacity of WM results from the race between decay and restoration: People can maintain as much information as they can reliably rehearse or refresh before it decays beyond recovery.

Resources

The concept of a limited resource is often used informally in cognitive psychology to describe the fact that the efficiency and

¹ We will use “restoration” as the general term for any hypothetical process by which decaying memory traces are restored, encompassing articulatory rehearsal, visual-spatial rehearsal, and attentional refreshing.

accuracy of information processing is limited. When used in this way, the term *resource* does not refer to an explanatory construct but rather summarizes a set of phenomena in need of explanation. In contrast to this informal use of the term, there is a more formal, well-defined resource concept (Anderson, Reder, & Lebiere, 1996; Ma et al., 2014; Navon & Gopher, 1979; Tombu & Jolicoeur, 2003). Well-defined resource concepts differ in their details but they share a set of assumptions: A resource is a limited quantity that enables a cognitive function (e.g., holding a representation available) or process (e.g., retrieving or transforming a representation), such that its efficiency and success probability increases monotonically with the resource amount allocated to it. The resource can be allocated flexibly to a broad range of representations and processes, and it can be subdivided into portions allocated in parallel to different recipients. Resource sharing implies that prioritizing one cognitive function or process occurs at the expense of others that need the same resource at the same time. It is this well-defined resource concept, rather than the unconstrained informal notion of resources, that we consider as a possible explanation of the capacity limit.

The precise predictions of a resource theory depend on the assumptions the theory makes in two regards: Which cognitive functions or processes need the resource, and how the resource quantity assigned to a function or process translates into an observable level of performance (i.e., the so-called performance-resource function; Norman & Bobrow, 1975). Here we consider the family of resource theories characterized by the following assumptions: (a) Maintaining a representation in WM requires allocating some amount of a resource to it for the duration of maintenance, and the success in maintaining a representation is a monotonically increasing function of the resource amount allocated to it. (b) Carrying out a cognitive operation requires allocating part of the resource to it for the duration of the operation; the speed and accuracy of the operation is a monotonically increasing function of its resource share. (c) Maintenance and cognitive operations require the same resource, at least within a broad content domain (i.e., verbal, visual, and spatial).

Whereas most resource theories assume that resources can be subdivided into quantities of any size, a more constrained version of resource theory—slot theory—has gained popularity in the literature on visual WM (Fukuda, Awh, & Vogel, 2010; Luck & Vogel, 2013; Zhang & Luck, 2008). According to slot theories, the resource underlying short-term maintenance of information consists of a limited number of discrete units or slots that can be allocated to individual items or chunks. As a consequence, the resource is not infinitely divisible—when K slots are available, WM can at best hold representations of K chunks. If a task requires holding more than K elements in WM, only a subset of K elements can be represented in WM and no information is available about any additional elements. Here we are not concerned with the debate between proponents of discrete slots and proponents of continuous resources (for a systematic comparison in the visual domain see van den Berg, Awh, & Ma, 2014), and instead treat both positions as members of the family of resource explanations of WM capacity. Because the assumption of continuously divisible resources is more flexible than the discrete-resource notion, in the following we focus on the hypothesis of continuous limited resources. Any challenge arising from the data for the continuous version of the resource hypothesis also applies to the version

assuming that the resource consists of discrete slots because the latter's lesser flexibility can only accentuate but not resolve any challenges.

Interference

Interference accounts of the WM capacity limit assume that our ability to hold several representations available at the same time is limited by mutual interference between these representations. Three forms of interference have been identified theoretically; they are schematically illustrated in Figure 1.²

First, interference arises from the *confusion* between item representations. Interference by confusion arises naturally from a retrieval mechanism called *competitive queuing*, which is incorporated in many formal models of WM (Hurlstone, Hitch, & Baddeley, 2014; Lewandowsky & Farrell, 2008b). Competitive queuing describes retrieval from WM as a competition between several retrieval candidates that are activated at retrieval. The more a representation is activated, the more likely it is to be selected for retrieval. Some models assume that the activation is continuously maintained during the retention interval (Page & Norris, 1998), whereas others assume that representations are reactivated at retrieval through context cues (Burgess & Hitch, 2006). Context cues can be representations of the present list context (discriminating the current memory set from other memory sets in previous trials), ordinal list positions (discriminating items within lists), or spatial locations (discriminating items in spatial arrays). Confusion arises when competing representations are activated as strongly as, or even stronger than, the target representation. This happens when contextual cues are not sufficiently distinctive from each other to selectively cue the target information (see Figure 1A). As an intuitive analogy for interference by confusion, think of reading a printed text: With smaller line spacing the lines are harder to distinguish, and the chance increases that the reader's eye jumps to the wrong line. Interference by confusion is a feature of most computational models of WM, including those that attribute the capacity limit to decay (e.g., Burgess & Hitch, 1999; Oberauer & Lewandowsky, 2011; Page & Norris, 1998).

A second form of interference arises from *superposition* of several distributed representations. Distributed representations can be patterns of activations over a set of units in a neural network, or patterns of connection weights between units. When several such patterns are encoded, they are added together (i.e., superimposed), and as a consequence, each individual pattern is distorted by the others (see Figure 1B). The amount of distortion increases with the

² A fourth form of interference arises when memory items are maintained by persistent activation of their representations, and these representations inhibit each other. Lateral inhibition is a common feature of competitive (k-winner-takes-all) networks, and it underlies the buffer model developed by Davelaar, Goshen-Gottstein, Ashkenazi, Haarmann, and Usher (2005) as a component of their model of free recall. In this model each item is represented by a unit that reactivates itself and inhibits all other units. As set size increases, the number of active units in the buffer increases up to a point where the sum total inhibition a unit receives from all other units exceeds its self-activation, so that the unit's activation rapidly drops to zero, and the corresponding item is irreversibly forgotten. Although technically an interference model, the buffer model behaves essentially like a resource model (including the irreversibility assumption discussed in the context of resource theories below). Therefore, we focus in this section on the remaining three forms of interference.

A: Confusion

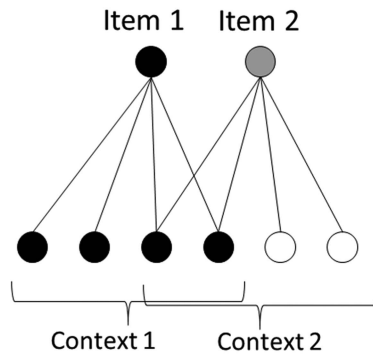

B: Superposition

Item 1:	-1	1	1	0.5
Item 2:	1	-1	1	0.5
Retr. 1:	-0.5	0.5	1.5	0.75

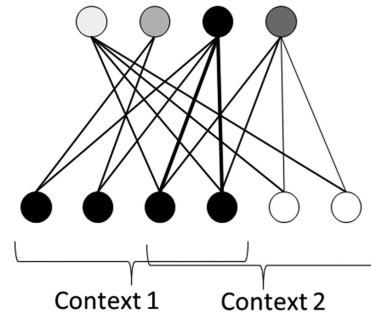

C: Feature Overwriting

Item 1:	-1	1	1	0.5
Item 2:	1	-1	1	0.5
Retr. 1:	-1	1	0	0



Figure 1. Three forms of interference. (A) Interference by confusion: Two items, each represented by a single unit in a neural network, are associated to two partially overlapping contexts. The figure shows the degree of activation (darkness of shading) at retrieval, using Context 1 as retrieval cue. Because of context overlap, Item 2 is activated little less than Item 1, such that with the addition of random noise, Item 2 could win the competition for retrieval. (B) Interference by superposition: Distributed representations of two items—shown as vectors and as patterns of shading of the units of a neural network—are associated to their respective contexts. The associations are superimposed in the matrix of connection weights between item and context units. At retrieval, when Context 1 is used as cue, the retrieved vector (Retr. 1) is a superposition of Items 1 and 2 (Item 2 contributing less because of only partial context overlap). The retrieved vector is a distorted version of the original Item 1. (C) Interference by feature overwriting. Two distributed item representations are shown, together with the retrieved vector when Item 1 is recalled. The two right-most features, which are shared by two items, have been overwritten.

number of patterns that are superimposed. Intuitively, interference by superposition can be understood in analogy to a printer that prints two or more words on top of each other, as in a palimpsest: The more words are superimposed on a page, the harder it gets to reconstruct each of them. Interference by superposition arises naturally in models of WM that use distributed representations (G. D. A. Brown, Preece, & Hulme, 2000; Farrell & Lewandowsky, 2002; Matthey, Bays, & Dayan, 2015; Oberauer, Lewandowsky, Farrell, Jarrold, & Greaves, 2012). Direct evidence for this form of distortion of WM representations comes from experiments using stimuli from low-dimensional feature spaces that enable precise control over the features of memoranda. For instance, Huang and Sekuler (2010) asked participants to reproduce the spatial frequency of one of two gratings held in WM, and found that the reproduced frequency was biased toward the frequency of the other grating (cf. Dubé, Zhou, Kahana, & Sekuler, 2014). Similar biases from distractors have been shown in auditory

(Mercer & McKeown, 2010) and tactile (Bancroft, Servos, & Hockley, 2011) STM.

Finally, interference could arise from *feature overwriting* as defined in the feature model of Nairne (1990) and the interference model of Oberauer and Kliegl (2001, 2006). Like superposition, the idea of feature overwriting applies to distributed representations in which each item is coded as a vector of features. Feature overwriting means that when two items share a feature, that feature is overwritten in one of them (Figure 1C). As an analogy, think of a type-setter with a limited number of types for each letter: When a new text requires a letter that has already been used, the needed letters are cut from the older text and pasted into the new text, leaving gaps that render the older text increasingly illegible. Feature overwriting is in some sense the opposite of superposition: Interference by superposition leads to distortions of distributed representations where they *differ* from each other, whereas feature overwriting leads to distortion of representations where they *match*

(compare Figures 1B and 1C). As a consequence, interference by superposition is more severe if the representations interfering with each other are dissimilar, whereas interference by feature overwriting is more severe when they are similar. There is some evidence for feature overwriting in WM for verbal materials (Lange & Oberauer, 2005; Oberauer & Lange, 2008), but not with visual materials (Jünger, Kliegl, & Oberauer, 2014). One series of experiments (Oberauer, Farrell, Jarrold, Pasiiecznik, & Greaves, 2012) tested the opposing predictions of the two mechanisms of interference and obtained support only for the superposition mechanism.

Evaluation of the interference hypothesis is facilitated by the fact that we can rely on computational models for determining its predictions. The two forms of interference most favored by the evidence—interference by confusion of items, and interference from superposition—are implemented in a computational model of WM, the SOB-CS model (Oberauer, Lewandowsky, et al., 2012), which allows us to determine what predictions the mechanisms imply when operating jointly. The combination of interference by confusion with feature overwriting is implemented in the model of Oberauer and Kliegl (2001, 2006). Computational models assist in unambiguously deriving predictions from theoretical assumptions, making the process of evaluating these assumptions in light of data more rigorous (Farrell & Lewandowsky, 2010). Therefore, we will rely, where possible, on computational interference models to unambiguously determine the predictions following from the interference hypothesis as specified in this section.

In what follows we present the competition between the decay hypothesis, the resource hypothesis, and the interference hypothesis across three rounds, one for each of the three broad sets of findings. Within each round we first provide a brief summary of the informative findings speaking to the phenomenon discussed in that round, followed by a discussion of each hypothesis in turn, during which we will introduce details on the informative findings as they become relevant in light of the specific predictions of each hypothesis. For most findings we present at least one representative study in a figure that explains the study design and shows the relevant data.

Round A: The Set-Size Effect

Every test of WM asks people to temporarily hold a set of mental content elements—such as digits, words, sounds, or visual objects—available for some mental operation. The operation to be carried out could consist of reporting the set after a delay, making a recognition judgment on elements of the set, or manipulating elements in the set. The accuracy of the requested operation typically declines with increasing size of the set to be held in WM—also known as the *memory load*. This set-size effect on accuracy can be regarded the most direct and unambiguous manifestation of the capacity limit of WM.

A controversial issue tightly linked to the nature of WM capacity is what scale is most appropriate for measuring WM load. On the decay hypothesis, WM load should be measured in terms of the time it takes to rehearse or refresh a memory set (Schweickert & Boruff, 1986). In contrast, the resource hypothesis and the interference hypothesis assign no role to time per se. According to the resource hypothesis, WM load should be quantified in terms of the number of chunks among which the resource needs to be distrib-

uted (Cowan, 2005), perhaps with larger weights for more complex chunks if it is assumed that they require a larger resource share. The interference hypothesis implies that the degree of mutual interference increases with the number of representations in WM, but also depends on the relations of overlap and similarity between them, as we will explain in more detail.

For these reasons we regard evidence on whether memory is a function of the number of elements, their complexity, and/or the time it takes to restore them as diagnostic for our question. As we review in detail below, current findings imply that both the number of elements in a memory set and their complexity affect performance. This pattern (finding A1a in Table 2) has been observed consistently with both verbal materials (Chen & Cowan, 2005; Service, 1998) and visual materials (Alvarez & Cavanagh, 2004; Hardman & Cowan, 2015), for different forms of complexity. Representative data are reproduced in Figure 2. In contrast, there is no evidence for an effect of time needed for rehearsal or refreshing on memory once other variables—such as the complexity of the memoranda—are controlled (A1b; Jalbert, Neath, Bireta, & Surprenant, 2011; Service, 1998).

A second piece of evidence shows directly that the set-size effect arises independently of time: The typical limitation of visual WM to about 2–3 objects has been found even at a retention interval of zero (Sewell, Lilburn, & Smith, 2014; Tsubomi, Fukuda, Watanabe, & Vogel, 2013). This finding (A2 in Table 2) is illustrated in Figure 3.

Another controversial issue concerning the set-size effect is whether materials from different content domains (i.e., the verbal, visual, or spatial domain) tax the same capacity limit. The set-size effect is in part *domain specific* (A3): Increasing the memory set by adding items from the same domain has been found to impair memory more than adding items from a different domain. Dual-set studies asking participants to remember two sets of materials from different domains (e.g., spatial locations and digits) have consistently found a reduced—and sometimes no—effect of the size of one set on memory for the other, suggesting separate capacity limits for the verbal and the visual-spatial domain (Cocchini, Logie, Della Sala, MacPherson, & Baddeley, 2002; Cowan, Saults, & Blume, 2014; Fougny & Marois, 2011; Fougny, Zughni, Godwin, & Marois, 2015; Oberauer & Kliegl, 2006; Towse & Houston-Price, 2001).

At the same time there is also robust evidence for a *cross-domain set-size effect* (A4), implying a domain-general capacity limit (Cowan et al., 2014; Oberauer & Kliegl, 2006; Saults & Cowan, 2007). Set-size effects across domains have been found to be more pronounced if the task requires maintenance of bindings between items and their contexts, such as their list positions or their locations in space (Depoorter & Vandierendonck, 2009; Fougny & Marois, 2011; but see Cowan et al., 2014). Figure 4 shows representative data demonstrating both the cross-domain set-size effect and the additional domain-specific set-size effect.

The set-size effect is reduced not only for mixed sets from different content domains, but also with mixed sets of stimuli from different categories within a domain (see Figure 5). For instance, lists composed of a set of letters followed by a set of digits are recalled better than equally long lists consisting entirely of letters, and lists composed of digits followed by letters are recalled better than lists consisting entirely of digits (Sanders & Schroots, 1969). Likewise, visual arrays of four objects are easier to remember

Table 2

Summary of Informative Findings and Evaluations of Hypotheses in Round A: Findings Characterizing the Set-Size Effect on Accuracy

Index	Finding	Decay	Resource	Interference
A1	Memory depends on the number of elements in a memory set, and on the complexity of the elements (e.g., number of phonemes in a word, or number of features of a visual object) (A1a), but not on the duration of reproducing the memory set (A1b)	–	+	0
A2	The set-size effect is also observed with a retention interval of zero	–	++	++
A3	The set-size effect is in part domain-specific: Memory sets mixing elements from different content domains are easier to remember than domain-pure sets	+	+	++
A4	Cross-domain set-size effect: Extending a memory set by adding elements from a different content domain impairs memory	+	++	0
A5	Heterogeneity benefit: Memory is better for heterogeneous sets (consisting of items from different classes) than for homogeneous sets within a domain	–	–	++

Note. Table entries reflect our judgment of the logical relation between a finding and a hypothesis: The hypothesis predicts (++) or can explain (+) the finding, it is consistent with the finding (0) or it is challenged by the finding (–); see text for explanation.

when people have to remember the colors of two objects and the orientations of the other two objects, compared with when they need to remember four colors, or four orientations (Olson & Jiang, 2002), and mixed arrays of shapes and textures are better remembered than pure arrays of one kind of feature (Delvenne & Bruyer, 2004). We will refer to this phenomenon as the *benefit of set heterogeneity* (A5). Although set heterogeneity within a domain has been investigated less often than the effects of domain combinations, the benefit of heterogeneous sets has been observed consistently. In what follows we review how well each of the three hypotheses accounts for the findings A1 to A5.

Decay

The units of measurement of the capacity limit (A1, A2). Under a decay account the set-size effect can be explained as an effect of the time it takes to sequentially restore a memory set of a given size: Larger sets take longer to rehearse or refresh, increasing the risk of memory contents being lost through decay before they can be strengthened again. The duration of articulatory rehearsal can be measured, at least approximately, by the time it takes a person to speak a list of verbal items aloud (Mueller, Seymour, Kieras, & Meyer, 2003). On that basis the capacity of WM for verbal materials has been estimated to correspond to an articulation duration of about 2 s (Schweickert & Boruff, 1986). In contrast, there is no established method for measuring the duration of refreshing. Vergauwe, Camos, and Barrouillet (2014) proposed a refreshing rate of 50 ms per item. The capacity of WM for visual materials, which cannot be maintained through articulation or the allocation of spatial attention and, therefore, must rely entirely on refreshing, rarely exceeds four items (Luck & Vogel, 1997; cf. Cowan, 2001). If this capacity limit arises because only about four items can be refreshed sequentially before they are lost through decay, visual WM representations would have to decay beyond recovery within 200 ms. This is highly unlikely because it would imply catastrophic forgetting of visual materials whenever central attention is diverted by only a single trial of a choice task, which already engages the attentional bottleneck for several 100 ms. No such catastrophic effects have been observed (Makovski, Shim, & Jiang, 2006; Ricker & Cowan, 2010).

Alternatively, refreshing could be assumed to proceed at a rapid rate, but with each refreshing event only strengthening the refreshed item by a small amount. With increasing set size, each item has to wait longer in between two refreshing events, implying that the amount of memory strength lost through decay in between refreshing events increasingly exceeds the gain in strength through refreshing, leading to a net loss of memory strength over time. With these assumptions there is no constant capacity limit—either measured in terms of total refreshing duration or of number of items—beyond which any additional WM contents would be instantly forgotten. Rather, as the memory set increases, there is an increasing rate of net loss of memory strength over time, resulting in an increased rate of forgetting.

Even if it does not imply a constant capacity limit on the time dimension, the decay hypothesis predicts that memory declines as the time required for restoration of an item increases. In the following section we show that, on balance, the evidence fails to support that prediction (finding A1b).

Is the set-size effect an effect of rehearsal time? The idea of a time limit on WM has initially received support in the verbal domain from the word-length effect (Baddeley et al., 1975): Lists of words that take longer to say—and therefore arguably longer to rehearse by subvocal articulation—are harder to remember in order. The correlation between speaking duration and serial recall accuracy, however, could be because of a third variable related to both (Lewandowsky & Oberauer, 2008). Two such variables have been identified: First, when the speaking duration and the complexity (i.e., number of syllables) of artificial words is varied independently, memory depends on complexity but not duration (Service, 1998). When speaking duration is varied while holding the number of syllables constant, a word-length effect is found only for a specific set of materials but not others (Lovatt, Avons, & Masterson, 2000), suggesting that the purely time-based word-length effect reflects a confound between speaking duration and some other feature of words (see Figure 2B). Second, the number of orthographic neighbors in the language has recently been identified as a confounding variable (Jalbert, Neath, Bireta, et al., 2011; Jalbert, Neath, & Surprenant, 2011). Therefore, the word-length effect appears not to reflect an effect of rehearsal duration, but

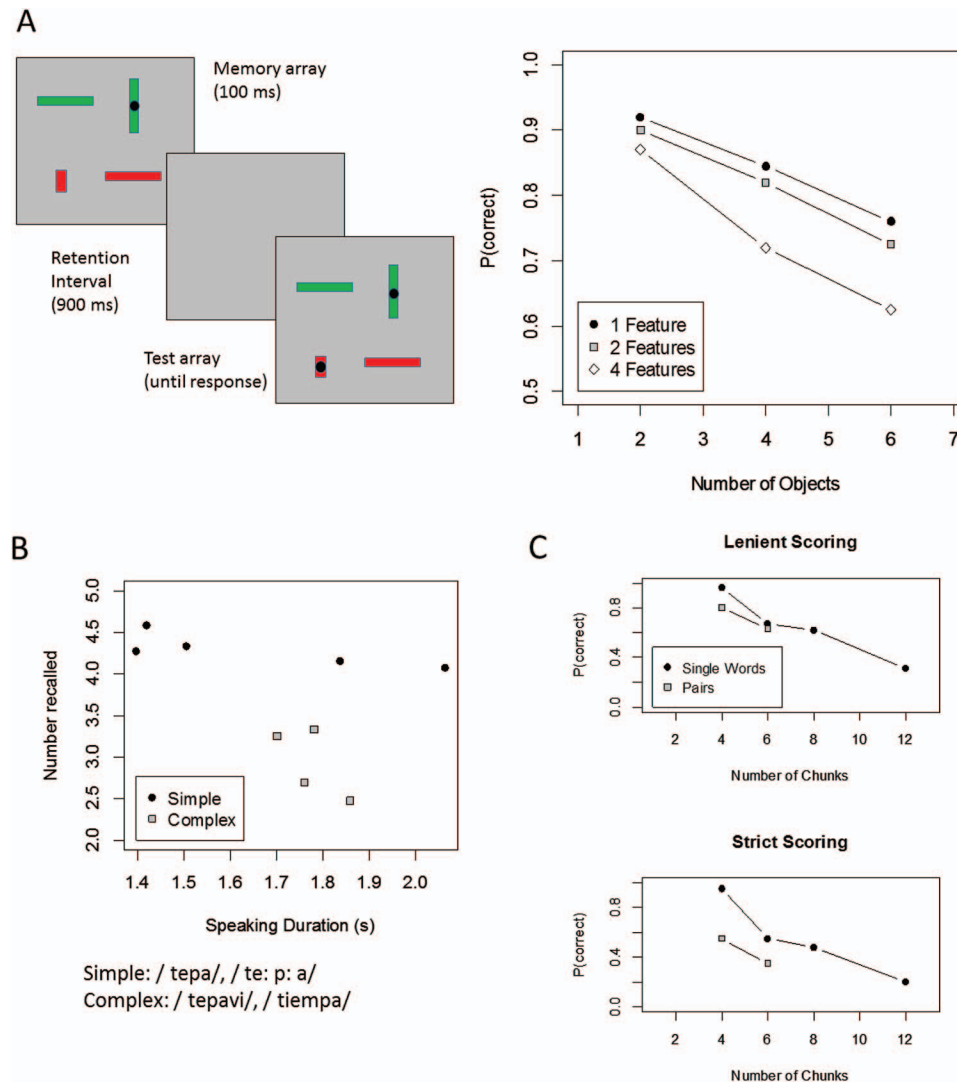

Figure 2. Memory depends on number and complexity of elements in the memory set (finding A1). (A) Change detection accuracy decreases with increasing number of objects and of features. The left panel shows a trial with four objects and four features (color, orientation, length, and presence or absence of a black dot); participants need to decide whether or not there was a change from the memory array to the test array. The right panel shows data redrawn from Figure 4A in [Hardman and Cowan \(2015\)](#): Accuracy declined with the number of objects and with the number of features per object. (B) Serial recall depends on complexity of pseudowords (i.e., the number of phonemes), not on speaking duration per word ([Service, 1998](#)). (C) Serial recall as a function of number of chunks in a list. Chunks could be single words or prelearned word pairs ([Chen & Cowan, 2005](#)). Lenient scoring reflects recall of words regardless of order; strict scoring reflects recall of words in correct list position. With lenient scoring, accuracy depended nearly exclusively on the number of chunks, regardless of their complexity (i.e., single vs. two-word chunks); with strict scoring, chunk complexity also affected accuracy. See the online article for the color version of this figure.

other variables such as word complexity or the density of a word's neighborhood in the mental lexicon.

Attempts to find evidence for a correlation between memory and rehearsal duration for spatial memoranda have had mixed success: [Smyth and Scholey \(1994\)](#) manipulated the relation between size and distance of stimuli in the Corsi block task.³ Displays with smaller stimuli separated by a larger distance increased the time for moving between the stimuli at recall but had no effect on

memory accuracy. [Parmentier, Elford, and Maybery \(2005\)](#) found that memory for serial order of spatial locations declines with increasing length of the path connecting subsequent locations, as

³ In the Corsi-block task, participants see an irregular spatial array of "blocks," which are highlighted in turn, and they try to reproduce the order of highlighted blocks by pointing at them.

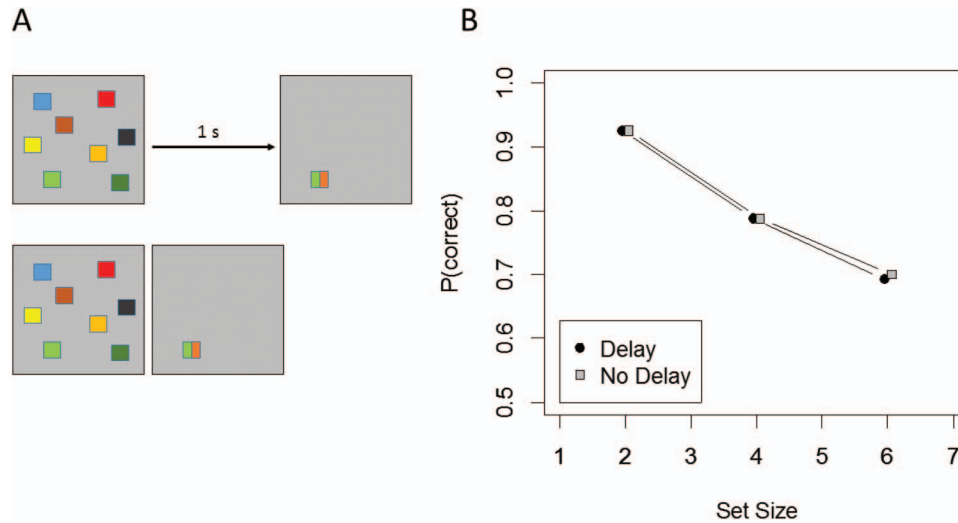

Figure 3. The set-size effect for visual arrays is observed even at a retention interval of zero (finding A2), as shown by Tsubomi et al. (2013): Participants remembered arrays of colored squares of varying set sizes. After a retention interval of 0 (no delay) or 1 s (delay), memory was tested by a bicolored square in the location of one array item. Participants decided which of the two colors in the probe matched the original color in that location in the array. (A) Example trials of the standard memory condition with a 1 s retention interval (above), and the zero retention-interval condition (below); (B) Data of Experiment 1 of Tsubomi et al. (2013). Probability of a correct response was calculated from the reported values of Cowan's K , an estimate of the number of items available in working memory (WM; Cowan, 2001). Accuracy declined with set size but was indistinguishable between the two conditions, implying that decay cannot explain the capacity limit that causes the set-size effect. See the online article for the color version of this figure.

well as with increasing path complexity (e.g., number of path crossings). In a review of the relevant literature, Parmentier (2011) came to the conclusion that these effects of path characteristics are more likely to arise from difficulties during encoding rather than from delays imposed during maintenance. This conclusion meshes well with the conclusion that effects of word length on verbal serial recall result from complexity rather than articulation duration of the words.

Taken together, neither the word-length effect nor the corresponding movement-length effects in spatial serial recall provide good evidence for a role of rehearsal duration in memory. At the same time, the data reviewed above do not rule out the more general assumption that the duration of processes during maintenance and retrieval affects memory. For instance, words from a sparse orthographic neighborhood could be harder to retrieve, leading to longer retrieval times and by implication, more decay of the remaining list words. In support of this notion, Cowan et al. (1992) observed that recall of all list words was impaired when the first three words to be recalled were long compared with when they were short. However, Lovatt, Avons, and Masterson (2002) were able to replicate this effect only with the specific set of words used by Cowan, and even then the effect was eliminated when the analysis was limited to trials in which the first three words were recalled correctly, implying that it is not the recall duration of the initial words but recall errors that adversely affected recall of further words.

The prediction that recall duration affects memory is further called into question by findings dissociating memory performance

from the duration of recall. For instance, Doshier and Ma (1998) investigated serial recall of digits, letters, and single-syllable words as a function of output duration. They found that proportion correct was well described by a decreasing function of output duration, regardless of list length and material. These functions, however, differed substantially for spoken recall and recall via keyboard—the latter took about 50% longer but resulted in equally good memory performance. Other studies manipulated the pace of recall either through instruction or the duration of intervening activity, and found no effect on memory (Cowan et al., 2006; Lewandowsky et al., 2004; Oberauer & Lewandowsky, 2008). In conclusion, the time for overt reproduction of memory items is not related to memory performance when confounding variables are taken into account (finding A1b). This result questions the assumption that memory depends on the time for restoring decaying traces, inasmuch as restoration involves covert reproduction of the material, for instance by articulatory rehearsal. There is still room for the assumption of a restoration process—such as refreshing—that is not thought to require reproduction of the material.

A capacity limit without delay. The set-size effect in visual WM cannot be explained as reflecting the race between decay and restoration, because the typical limitation of visual WM to about 2–3 objects has been found even at a retention interval of zero (A2). For instance, Tsubomi et al. (2013) presented participants with arrays of a variable number of colored squares for one second, immediately followed by a single bicolored square in the location of one of the squares in the memory array. The bicolored square served as a visual mask and as the response probe: Participants had

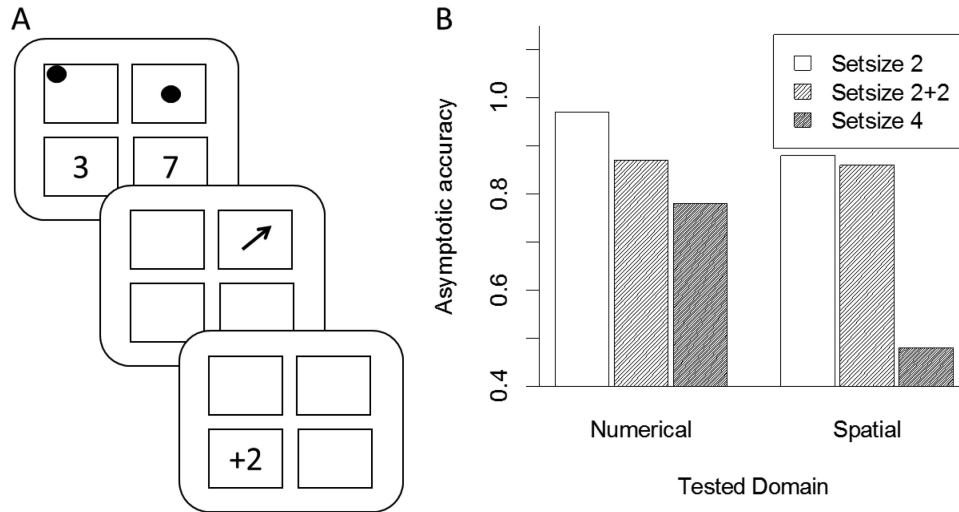

Figure 4. Domain-specific and domain-general set-size effects (findings A3 and A4). (A) Initial display and first updating step of a trial in the experiment of Oberauer and Kliegl (2006). After encoding two or four initial items, participants worked through eight successive updating steps; each step involved updating of one memory item. Numerical items (digits) were updated by arithmetic operations; spatial items (locations in the frame) were updated by mental shifts in the direction of the arrow. (B) Asymptotic accuracy (at sufficiently long presentation durations for each updating step) for set size 2 (two digits or two locations), set size 2 + 2 (two digits and two locations, illustrated in A), and set size 4 (four digits or four locations). Relative to set size 2, accuracy declined when adding two items from the other content domain (set size 2 + 2), showing the domain-general set-size effect. Accuracy declined more when adding two items from the same content domain (set size 4), showing the domain-specific set-size effect.

to decide which of the two colors of the bicolored square matched the color previously seen in the same location in the memory array. Capacity estimates with this procedure were indistinguishable from those with a 1-s retention interval (see Figure 3).

Proponents of decay could argue that encoding of a visual array into WM is a sequential process, so that at the time of test (i.e., when the target object is covered by the bicolored mask) some delay has already elapsed after encoding. This argument faces two problems. First, encoding of colors into WM takes about 50 ms per item (Vogel, Woodman, & Luck, 2006). A decay theory would have to assume that representations decay within 150 ms to explain why WM capacity is limited to about three objects. Second, Sewell et al. (2014) demonstrated that the stimuli of a visual array are encoded into WM in parallel: They compared simultaneous and sequential presentation of up to four visual stimuli, displaying each stimulus in the sequential condition for as long as the entire array in the simultaneous condition. If stimuli were encoded sequentially, performance should be worse in the simultaneous condition, whereas parallel encoding predicts no difference. Sewell and colleagues found no difference between presentation conditions, implying that stimuli were encoded in parallel. In the same experiment Sewell and colleagues replicated the observation of a set-size effect with a negligible retention interval.

The finding of a set-size effect without a delay does not rule out an impact of decay over retention intervals longer than one second, but it shows that the set-size effect—and by implication, the fact that WM capacity for visual materials is severely limited—does not arise primarily from a race between decay and restoration during a delay between encoding and test.

Effects of domain and of set heterogeneity (A3–A5). The decay hypothesis can offer a straightforward explanation for the cross-domain set-size effect (A4 in Table 2) by assuming a domain-general process of restoration, such as attentional refreshing. Memoranda from different domains—such as words and spatial locations—must time-share the sequential refreshing mechanism. Therefore, adding any additional information that needs to be refreshed impairs the chances of surviving decay for all other memoranda, regardless of their content domain (Vergauwe, Barrouillet, & Camos, 2010).

Decay theories can explain the partial domain-specificity of set-size effects (A3) by assuming that different content domains have separate rehearsal processes that can run in parallel. Decay theories agree in assuming that verbal memoranda are maintained through articulatory rehearsal, and some have argued for an analogous spatial rehearsal process based on shifts of spatial attention (Awh et al., 1998). A mixed set of verbal and spatial items could be easier to remember than a pure set of either material because parallel articulatory and spatial rehearsal could maintain the verbal and spatial subsets of a mixed set, respectively, without competing for time.

More problematic for decay-rehearsal theories is the benefit of heterogeneous sets *within* a domain (A5). For instance, the finding that mixed sets of shapes and textures are easier to remember than pure sets of shapes or of textures (Delvenne & Bruyer, 2004; see Figure 5) would have to be explained by assuming independent, parallel restoration processes for shapes and for textures. Similarly, better memory for jointly remembering a list of consonants and a list of digits, compared with remembering two lists of the

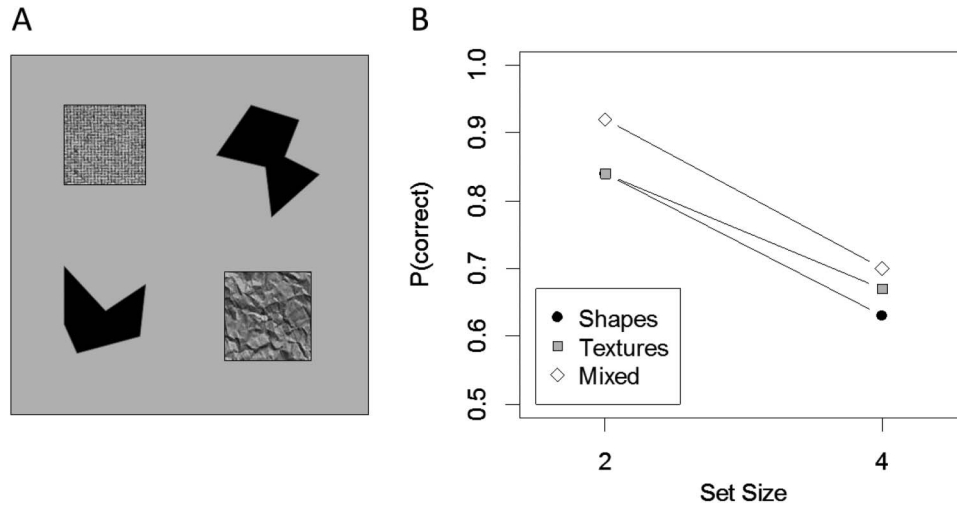

Figure 5. Heterogeneity benefit (finding A5). (A) Example of the mixed (heterogeneous) arrays, combining shapes and textures, in the change-detection experiment of [Delvenne and Bruyer \(2004\)](#). Participants tried to remember arrays of two or four stimuli for 0.9 s, and decided whether a single centrally presented probe stimulus matched one of the stimuli in the array. (B) Accuracy in homogeneous trials (Shapes: two or four shapes; Textures: two or four textures) and the heterogeneous trials (Mixed: one color and one shape, or two colors and two shapes). Performance was better for heterogeneous arrays than for both kinds of homogeneous trials, demonstrating the heterogeneity benefit.

same category ([Sanders & Schroots, 1969](#)), would have to be explained by assuming separate, parallel processes of restoration for digits and for consonants.

One could argue at this point that a decay account of the WM capacity limit could explain the heterogeneity advantage by appealing to additional mechanisms. For example, it could be assumed that, in addition to decay, items in homogeneous sets interfere more with each other than items in heterogeneous sets (see our discussion of interference below). This move would delegate much of the explanation of the set-size effect to interference, raising the question whether decay is still needed to explain one of the main empirical manifestations of the capacity limit of WM.

Conclusion. The findings characterizing the set-size effect provide little support for the idea that the set-size effect arises from a race between decay and restoration: The set-size effect is not an effect of the time it takes to rehearse the memoranda. The heterogeneity benefit is difficult to explain by the decay hypothesis. Perhaps the most decisive evidence against an explanation of the set-size effect in terms of decay is the fact that the set-size effect is observed even in the absence of any time interval over which decay could express itself.

Resources

Assuming that a resource is needed for maintenance in WM, the resource hypothesis provides a straightforward explanation of the set-size effect: As the number of representations held in WM increases, the resource must be divided among more elements, leaving each of them with a smaller share. Resource models have been very successful in quantitatively accounting for the effect of set size on the precision of recall of visual features ([Bays, 2014](#); [Ma et al., 2014](#); [van den Berg et al., 2014](#)).

The units of measurement of the capacity limit (A1, A2).

The resource hypothesis entails no commitment concerning what counts toward the load on WM capacity: If the performance-resource function is assumed to be the same for all kinds of representations, then the only variable that affects WM performance is the number of objects or chunks among which the resource is to be shared. Alternatively, a resource theory can assume that more complex chunks require more resources to achieve the same level of memory performance. [Chen and Cowan \(2005\)](#) have systematically investigated the contributions of the number and the complexity of chunks to performance on a verbal WM test. They varied complexity by contrasting single-word chunks to two-word chunks consisting of pairs that participants had learned to criterion before WM testing commenced. [Chen and Cowan \(2005\)](#) found that memory for the occurrence of items on a list, regardless of their order, depends on the number of chunks to be remembered (for a replication see [Chen & Cowan, 2009](#)). In contrast, memory for the serial order of items in a list is better characterized as a function of the complexity of the chunks (see [Figure 2C](#)).

For visual stimuli, [Alvarez and Cavanagh \(2004\)](#) noted that performance on change-detection tasks correlates with the visual complexity of the to-be-remembered visual objects. For instance, change detection is better for arrays of colored squares than for arrays of Chinese characters when the number of objects is the same. [Awh, Barton, and Vogel \(2007\)](#) argued that this finding merely reflects the fact that changes in more complex objects are more subtle and, therefore, a more precise representation is needed to detect them. However, [Brady and Alvarez \(2015\)](#) showed that people can remember a greater number of simple objects than complex objects even when the changes in the complex-object trials are drastic, such as replacing a cube by a Chinese character.

This result confirms that the complexity of visual objects affects WM performance. Other research operationalizing complexity as the number of visual features to be remembered for each object found that memory declines with object complexity even when the required precision is held constant (Cowan, Blume, & Saults, 2013; Hardman & Cowan, 2015; Oberauer & Eichenberger, 2013; see Figure 2A for representative results).

At least for visual WM, Cowan and his colleagues have proposed an explanation of the effects of both the number of chunks and the number of features per chunk (i.e., one aspect of complexity) within a discrete-resource account (Cowan et al., 2013). Therefore, although the details of how different aspects of complexity affect different aspects of performance are not yet well understood, we argue that the resource account is able to offer a reasonable explanation for the finding that WM performance depends both on the number and the complexity of elements in the memory set (A1).

The resource hypothesis correctly predicts that the set-size effect is observed even at a negligible RI (A2: Sewell et al., 2014; Tsubomi et al., 2013): The competition for resources takes place as soon as a memory set is encoded and does not change while that set needs to be maintained.

Effects of domain and of set heterogeneity (A3–A5). As long as all elements in a memory set compete for the same resource, the set-size effect should be the same for sets of homogeneous and for sets of heterogeneous elements. The assumption of a general resource predicts the cross-domain set-size effect (A4), but it is insufficient to explain domain-specificity of set-size effects (A3): The dual-set studies reviewed above show that memory is better for mixed sets of items from different domains than for pure sets of equal size (Cocchini et al., 2002; Oberauer & Kliegl, 2006). Resource theories have accounted for this fact by assuming separate resources for verbal and for visuospatial materials (Baddeley, 1986; Logie, 1995).

More problematic for the resource hypothesis is the heterogeneity benefit (A5). To account for better memory for mixed than for pure sets within the verbal or the visual domain (e.g., mixed lists of digits and letters, or of colors and orientations), resource theories would have to assume separate resources for digits and letters, or for different kinds of visual features. This is logically possible but questions the elegance and parsimony of any resource theory of WM.

Conclusion. The resource hypothesis offers a viable explanation for the set-size effect. The only challenge for the resource hypothesis arises from the heterogeneity benefit.

Interference

Interference depends on the relations between representations in WM. A representation is conceptualized as a set of features, which can be described as a vector of feature values across several feature dimensions (Nairne, 1990), as a point in a feature space defined by these feature dimensions (G. D. A. Brown, Neath, & Chater, 2007), or as a pattern of activation across a set of units in a neural network (Farrell & Lewandowsky, 2002; Lewandowsky & Farrell, 2008b). To characterize the relation between two (or more) representations in WM we need to distinguish two aspects (for a more detailed treatment see Oberauer, Lewandowsky, et al., 2012). One is the degree of *overlap of the feature spaces* in which two items

are represented, that is, what proportion of their feature dimensions they have in common. The other is *similarity*, defined as the proportion of features two items have in common within the same feature space. For instance, when a memory set consists of a red circle and a blue square, the two items vary on two dimensions, both of which they share—both items have a color and a shape. At the same time, the two items share none of their features. In this memory set, feature-space overlap is perfect, but similarity is zero. In contrast, consider a memory set consisting of a red circle and a spoken syllable. These two items share few, if any, feature dimensions, because—leaving aside the possibility of synaesthesia—spoken syllables have no color and no shape, and geometric figures have no phonological features.

The two kinds of relations between representations—similarity and feature-space overlap—have different consequences for the three kinds of interference—interference by confusion, interference by superposition, and interference by feature overwriting. The degree of *interference by confusion* decreases with decreasing similarity and with decreasing feature-space overlap, because items are less likely to be confused the fewer features, and the fewer feature dimensions, they have in common. Likewise, *interference by feature overwriting* decreases with decreasing similarity and decreasing feature-space overlap because of the decreasing proportion of shared features between representations. *Interference by superposition*, in contrast, increases with decreasing similarity, because two representations in the same feature space distort each other more severely the more their values on each feature dimension differ from each other (see Figure 1). For instance, superimposing a red circle with a red square leads to mutual distortion of the shape but not the color of each item, whereas superimposing a red circle with a blue square leads to distortion on both feature dimensions. Interference by superposition decreases as the degree of feature-space overlap decreases, because the distortion caused by superposition arises from summing (or averaging) feature values within a shared feature dimension. In a neural-network model such as SOB-CS, different feature spaces are implemented as different sets of units over which representations are distributed (Oberauer, Lewandowsky, et al., 2012). A purely visual representation of a red circle and a purely phonological representation of a word do not interfere with each other because their distributed representations are distributed over different, nonoverlapping sets of units in a neural network.

The units of measurement of the capacity limit (A1, A2). From the interference perspective any attempt to measure WM load by counting or adding up some quantity characterizing individual memoranda—such as their number, their complexity, or their duration of restoration—is futile, because the capacity limit arises from the interaction between representations in WM. One and the same representation can generate much interference in the context of one memory set (e.g., a noun among other nouns), and very little interference in the context of another (e.g., the same noun among a set of colors). That said, everything else being equal, the interference hypothesis predicts that memory declines as the number of elements in the set increases, because more representations in WM imply more mutual interference between them. The interference hypothesis makes no general prediction about the effect of complexity. Some instances of a complexity effect can easily be accommodated by the interference hypothesis. For instance, the fact that more complex words—consisting of more

syllables or more phonemes—are harder to remember (Service, 1998) arises naturally in an interference model because more complex words introduce more information into the same (phonological) feature space, thereby increasing interference. Other instances of the complexity effect are more challenging for the interference hypothesis. For instance, WM for visual objects declines as more features on different feature dimensions need to be remembered for each object (Hardman & Cowan, 2015; Oberauer & Eichenberger, 2013), although there is no reason why adding information on one feature dimension (e.g., shape or size) should interfere with information on another feature dimension (e.g., color). On balance, the interference hypothesis is consistent with finding A1, but it does not predict or explain it.

Interference is instantaneous—as soon as two or more representations enter WM, they interfere with each other. Interference limits the information that can be held in WM simultaneously, not its retention over time. Therefore, the interference hypothesis correctly predicts that a set-size effect is observed even at a negligible retention interval (A2).

Effects of domain and of set heterogeneity (A3–A5). An interference account of WM capacity necessarily predicts that memory sets of items from different content domains are easier to remember than domain-pure sets (A3). Mixed sets of verbal and nonverbal items are easier to remember than pure sets because verbal and nonverbal representations have relatively little feature-space overlap, thereby reducing the chance for all three kinds of interference. A specific prediction following from interference by confusion is that, compared with pure lists, mixed lists lead to fewer confusions between list items, in particular between items from different categories. This has been found for mixed lists of verbal, visual, and spatial items (Farrell & Oberauer, 2014).

The interference hypothesis also predicts the heterogeneity benefit within content domains (A5): Mixed sets of colors and orientations (Olson & Jiang, 2002) or of shapes and textures (Delvenne & Bruyer, 2004) are easier to recall than pure sets because of reduced feature-space overlap: These kinds of items are represented in very low-dimensional feature spaces that do not overlap. Mixed sets within the verbal domain, such as combinations of digits and letters (Sanders & Schroots, 1969), arguably do not benefit from reduced feature-space overlap, because all verbal materials are encoded primarily through their phonological features, so that they share the feature space of phonetic features (Baddeley, 1966; Conrad, 1964). However, heterogeneous verbal lists benefit from reduced interference by confusion: A confusion of a digit with a letter is less likely than confusions within each class of stimuli.

Whereas interference theories provide an explanation for the effects of domain specificity and of set heterogeneity, they have no ready explanation for the cross-domain set-size effect (A4): Adding items to a memory set decreases memory even when the items have no apparent feature-space overlap with each other, such as spoken digits and arrays of colors (Morey & Cowan, 2004; Saults & Cowan, 2007). Representations with no feature-space overlap should not interfere with each other. A possible explanation for mutual impairment of memory for such very different stimuli is that their representations share feature dimensions that are not apparent from a description of the nominal stimuli. The way people represent a stimulus does not necessarily match the way the experimenter describes it. For instance, Walsh (2003) summarizes

evidence that several apparently different dimensions of quantity, such as space, time, and numerical quantity, share a common representational medium. Therefore, spoken digits could activate numerical quantities that overlap with the spatial arrangement of colors in an array, leading to some interference between digits and color arrays. The studies reviewed by Walsh (2003) thus provide an existence proof for cross-domain representational overlap that is not apparent from a surface analysis of the stimuli. However, for this kind of explanation of the cross-domain set-size effect to be satisfying, independent evidence must be provided for the overlap of representations of the specific stimuli used in each particular experiment.

Conclusion. The interference hypothesis provides a viable explanation of the set-size effect. It is consistent with the effects of number and complexity of memoranda, and it predicts the capacity limit in the absence of a retention interval. The interference hypothesis predicts that interference is smaller between than within domains, and smaller for heterogeneous than homogeneous sets within a domain. At the same time, an interference account has yet to offer a convincing explanation for why even very different memoranda, with apparently minimal feature-space overlap, interfere with each other in WM. Therefore, we can at best say that the hypothesis is consistent with a cross-domain set-size effect.

Round A: Summary

Table 2 summarizes the score sheet of round A. The decay hypothesis was hit hardest by the data: It is challenged by the fact that the set-size effect is not an effect of time (A1, A2), and by the heterogeneity benefit within domains (A5). The resource and the interference hypothesis remain stronger contenders, with slightly more points for the interference hypothesis, because it predicts three of the findings, whereas the resource hypothesis predicts only two, and is challenged by one, the heterogeneity benefit.

Round B: Retention Interval and Distractor Processing

When trying to temporarily remember new information, concurrently engaging in an unrelated processing task impairs memory performance. This phenomenon has been regarded as a manifestation of the WM capacity limit since the early days of WM research (Baddeley & Hitch, 1974; Case et al., 1982; Daneman & Carpenter, 1980).

The degree to which distractor processing impairs memory depends on several characteristics of the distractor task. One well-replicated finding is that memory performance decreases as the *cognitive load* imposed by a distractor task increases (B1; Figure 6), where cognitive load is defined as the proportion of the available processing time during which central cognitive processes are actually engaged by the distractor task (Barrouillet, Bernardin, & Camos, 2004; Barrouillet et al., 2007; Conrad & Hull, 1966). In practice, cognitive load is usually varied through the pace at which a series of processing operations of roughly constant difficulty is required. For instance, Conrad and Hull (1966) asked participants to remember four consonants while reading aloud digits at a pace of 0.4 or 0.8 s per digit. Memory was impaired more when the same number of digits had to be read at a faster pace.

Independent of pace, the *duration* of distractor processing during the RI has been found to affect memory in some studies

Table 3

Summary of Informative Findings and Evaluations of Hypotheses in Round B: Findings on Retention-Interval and Distractor-Processing Effects

Index	Finding	Decay	Resource	Interference
B1	The impairment of memory by processing distractors in the retention interval increases with the cognitive load imposed by the processing task	+	–	+
B2	The duration of distractor processing in the retention interval affects memory if and only if distractors differ from each other	–	–	++
B3	The duration of an unfilled retention interval impairs visual and spatial WM in some experiments	+	0	–
B4	Domain-specific effect of processing: Processing distractors from the same content domain as the memoranda leads to a larger impairment	+	+	++
B5	Cross-domain impairment of memory by processing: Memory is impaired by processing of distractors from another domain than the memoranda	+	++	0
B6	Heterogeneity benefit: Processing distractors from different classes as the memoranda (within the same domain) impairs memory less than processing of distractors from the same class	–	–	++

Note. Table entries reflect our judgment of the logical relation between a finding and a hypothesis: The hypothesis predicts (++) or can explain (+) the finding, it is consistent with the finding (0) or it is challenged by the finding (–); see text for explanation. WM = working memory.

(Chechile, 1987; Conrad & Hull, 1966; Peterson & Peterson, 1959), but not in others (Barrouillet et al., 2004; Humphreys et al., 2010). One relevant moderator is the degree of *variability* of the distractor material processed (B2): If the material is highly repetitive—such as repeatedly speaking the same word—the duration of this activity has no effect on memory, at least for verbal memoranda. In contrast, when the processed material is variable—such as speaking different words—the detrimental effect on memory increases with the duration of processing (Lewandowsky, Geiger, Morrell, & Oberauer, 2010; Lewandowsky et al., 2008; McFarlane & Humphreys, 2012). Hence, at least for verbal memoranda,

whether or not memory declines over a filled RI depends on the variability of distractor processing (see Figure 7). At the same time, some studies using visual or spatial memoranda have found that extending the duration of the RI impairs memory even in the absence of a concurrent processing task (B3; Lilienthal, Hale, & Myerson, 2014; Mercer & McKeown, 2014; Ricker & Cowan, 2010).

Like the set-size effect, the impairment of memory by concurrent processing is in part domain-specific (B4): Having to process materials from the same domain as the memory content is more detrimental than having to process materials from

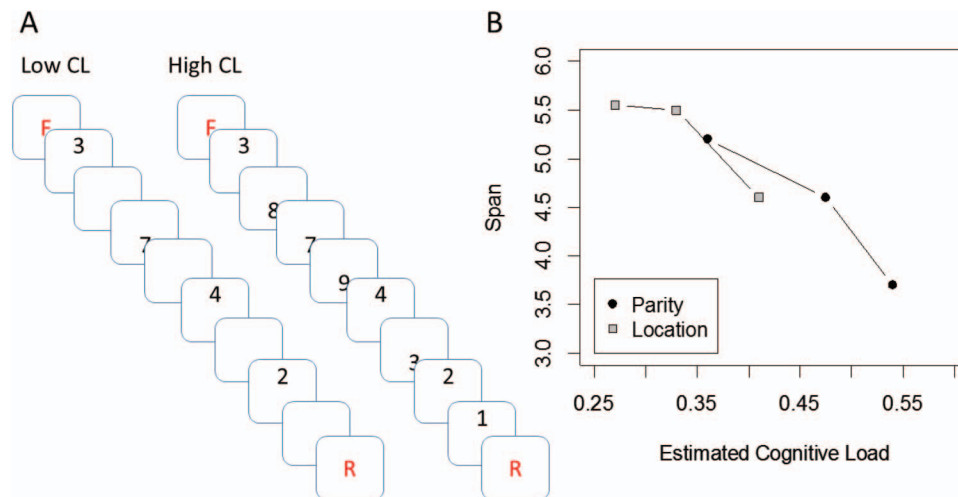

Figure 6. Effect of cognitive load by a distractor task (finding B1). (A) Example trials of Experiment 3 of Barrouillet et al. (2007). Participants remembered lists of letters, and in between made parity judgments or location judgments on digits. The figure shows the sequence of events between encoding of two list items (red letters) in a condition with low cognitive load (CL), in which participants have to make four judgments on digits, and a condition of high CL, in which they have to make eight judgments in the same total time. (B) Memory span as a function of cognitive load. Cognitive load was estimated as the summed response times of all judgments in between two letters, divided by the total available time. Memory is impaired more by a distractor task as the proportion of time spent on the distractor task increases. See the online article for the color version of this figure.

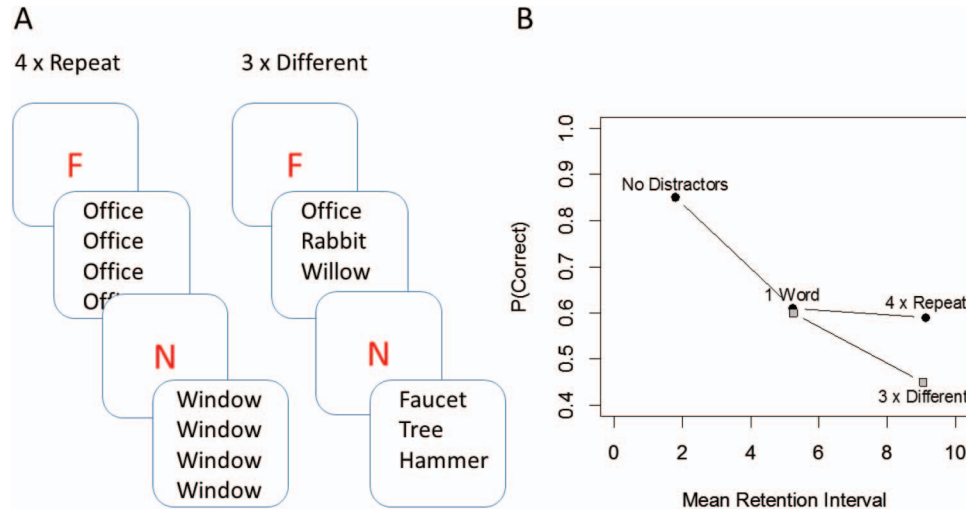

Figure 7. The effect of the duration of the retention interval depends on the variability of distractors processed in that interval (finding B2). (A) Example trials from Experiment 3 of Lewandowsky et al. (2010): Participants remembered lists of letters, and in between read distractor words aloud. (B) Relative to a baseline without reading of distractors, letter recall declined when one word was read after each letter. Accuracy did not decline further when the retention interval was extended by having participants repeat the distractor four times (no distractor variability), but it did decline when they read three different words (distractor variability). See the online article for the color version of this figure.

another domain (Chein, Moore, & Conway, 2011; Davis, Rane, & Hiscock, 2013; Hale, Myerson, Rhee, Weiss, & Abrams, 1996; Jarrold, Tam, Baddeley, & Harvey, 2010; Jarrold et al., 2011). In addition to this domain-specific effect of processing on memory, most studies have also found an—albeit smaller—impairment of memory by processing material in a different domain (B5; Chein et al., 2011; Jarrold et al., 2011; Vergauwe et al., 2010). For instance, memory for spatial patterns (Darley & Glass, 1975) and for color-shape conjunctions (Allen et al., 2006) is impaired by orally counting backward. Memory for spatial locations (Klauer & Stegmaier, 1997) and for colors (Makovski, 2012) is impaired by binary decisions on verbal stimuli, such as parity judgments on digits. Conversely, memory for verbal lists is impaired by nonverbal decisions (Jarrold et al., 2011; Vergauwe, Dewaele, Langerock, & Barrouillet, 2012). Both the domain-specific and the domain-general effect of distractor processing have been replicated numerous times. Figure 8 (top panel) illustrates these effects.

Finally, a heterogeneity benefit for distractor processing has been observed in all but one of the studies investigating it (B6; bottom panel of Figure 8): If memoranda and distractors come from the same domain, distractor processing damages memory less when memoranda and distractors are drawn from different categories than when they are drawn from the same category. For instance, memory for lists of digits is impaired more by concurrent processing of numbers than of words, whereas memory for lists of words is disrupted more by concurrent processing of words than of numbers (Conlin, Gathercole, & Adams, 2005; Li, 1999; Turner & Engle, 1989; for a partial exception to this pattern see Macken & Jones, 1995). Similarly, recall of lists of words is disrupted more by processing of other words than by processing of nonwords, whereas recall of lists of nonwords is disrupted more by processing

other nonwords than by processing of words (Conlin & Gathercole, 2006). We now discuss how the three hypotheses fare in light of findings B1 to B6, summarized in Table 3.

Decay

The initial motivation for assuming rapid decay of traces in short-term or WM came from the observation of rapid forgetting over an RI filled with a distractor task (J. Brown, 1958). The decay hypothesis implies that memory performance declines over an increasing RI if restoration processes such as rehearsal are prevented during that interval by a distractor activity. If restoration can be accomplished by both articulatory rehearsal and refreshing (Camos et al., 2009), then distractor processing preventing articulatory rehearsal (such as articulatory suppression)⁴ as well as distractor tasks engaging central attention (such as tasks requiring response selection or retrieval from long-term memory) are predicted to impair memory for verbal materials.

Cognitive load (B1). The decay hypothesis, together with the assumption of attention-based refreshing, can explain why memory declines with increasing cognitive load imposed by a concurrent distractor task that demands central attention (B1 in Table 3; Barrouillet et al., 2007). Cognitive load is defined as the proportion of time of the RI during which central attention is engaged by the distractor task. Refreshing is assumed to compete with the distractor task for the central attentional bottleneck. Therefore, higher cognitive load implies a larger

⁴ Articulatory suppression refers to asking participants to continuously say aloud a simple series of syllables, such as “ba, ba, ba . . .,” with the purpose of preventing articulatory rehearsal.

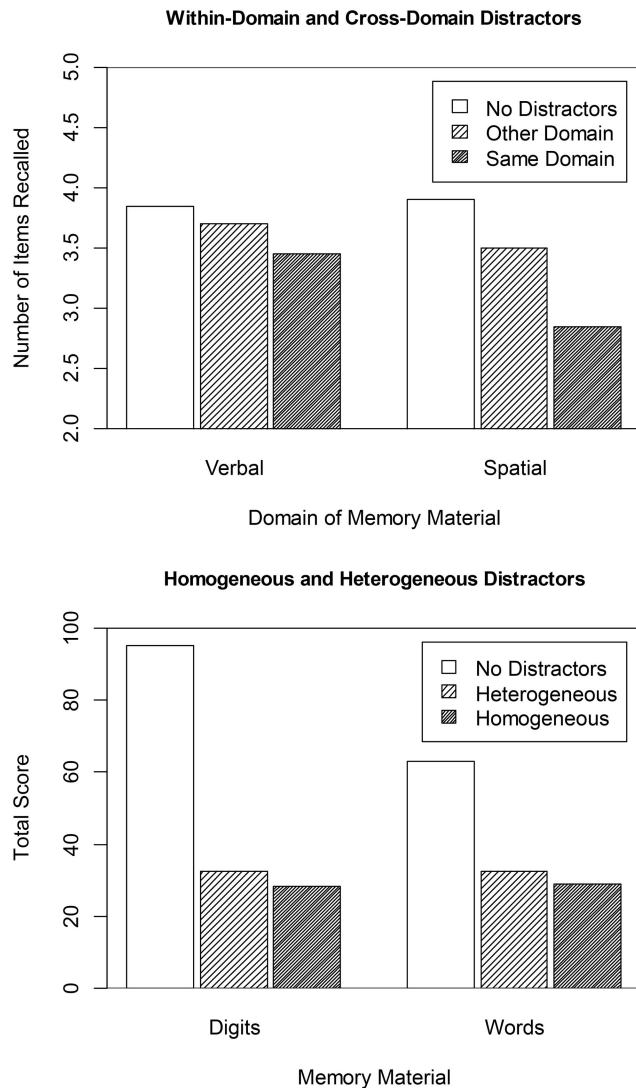

Figure 8. Top: Domain-specific effect (finding B4) and domain-general effect (finding B5) of distractor processing in the complex-span experiment of [Chein et al. \(2011\)](#): Participants remembered lists of letters (verbal) or of dot locations in a grid (spatial), combined with lexical decision (verbal) or symmetry judgments (spatial) as processing demand. Relative to a simple-span task with no processing assignment, memory was impaired by a processing demand in the other domain (domain-general effect), but was more impaired by processing in the same domain (domain-specific effect). Bottom: Heterogeneity benefit (finding B6) in the complex-span study of [Turner and Engle \(1989\)](#): Memory for digits was more impaired by concurrent processing of digits (a condition with homogeneous materials used for memory and distractor task) than of words (heterogeneous condition, using different materials for the memory and the distractor task). Conversely, memory for words was more impaired by processing of words (homogeneous) than of digits (heterogeneous).

proportion of time during which refreshing is prevented, leaving memory traces to decay, and a lower proportion of time during which decay can be counteracted by refreshing. Computational modeling has shown that with these assumptions the approximately linear effect of cognitive load on serial recall

performance can be explained ([Oberauer & Lewandowsky, 2011](#)).

Retention interval and the amount of distractor processing (B2, B3). If decay is to play any role in explaining the capacity limit of WM, it must lead to measurable forgetting when restoration is prevented. As decay theories assume different restoration processes for verbal and nonverbal memoranda, and the relevant evidence differs substantially between these domains, we discuss them separately.

Verbal memoranda. Two kinds of restoration processes have been assumed for verbal memoranda, articulatory rehearsal, and refreshing. [Camos et al. \(2009\)](#) asserted that the protective effects of rehearsal and of refreshing are additive. If the beneficial effects of rehearsal and refreshing are assumed to be additive, this implies that the effects of preventing each of these restoration processes also must be additive. Therefore, preventing either articulatory rehearsal or refreshing should lead to forgetting over time, and preventing both should lead to more rapid forgetting over time. Subvocal articulatory rehearsal can be prevented through articulatory suppression—asking participants to repeat a simple utterance continuously. Experiments varying the duration of a retention interval during which participants engaged in articulatory suppression found no decline of memory with longer retention intervals (B2; [Humphreys et al., 2010](#); [Lewandowsky et al., 2004](#); [Longoni, Richardson, & Aiello, 1993](#); [Phaf & Wolters, 1993](#); [Vallar & Baddeley, 1982](#)). Refreshing can be prevented by simple binary decision tasks that engage central attention ([Barrouillet et al., 2007](#)). Variations of retention intervals filled with binary decision tasks have not revealed any decline of memory over time ([Barrouillet, Portrat, Vergauwe, Diependaele, & Camos, 2011](#); [Oberauer & Lewandowsky, 2014](#)). Relaxing the assumption of additive benefits from rehearsal and refreshing would not help the decay hypothesis: Even when both forms of restoration are prevented by asking participants to engage in an attentionally demanding task and articulatory suppression at the same time, memory for lists of letters still does not decline over time ([Oberauer & Lewandowsky, 2008, 2013](#)). These findings are incompatible with a central prediction from the decay hypothesis.

It has been argued that the decay assumption can be reconciled with the finding that memory does not decline during a RI filled with restoration-preventing distractor activity. The argument is that memory performance depends on the cognitive load imposed by distractor processing, and because cognitive load is a proportion of two time intervals, it can be held constant as the RI is increased. Therefore, memory performance is predicted to stay constant over variations of the RI as long as cognitive load is held constant ([Barrouillet et al., 2011](#)). This argument is, however, not logically sound ([Oberauer & Lewandowsky, 2014](#)). From the observation that cognitive load has an effect on memory performance it does not follow that memory depends *only* on cognitive load. In fact, the decay assumption implies that memory depends on RI in addition to cognitive load. Specifically, decay implies that memory must decline with increasing RI for any constant level of nonminimal cognitive load, for the following reason: Consider the fate of a WM representation during any arbitrary, reasonably short interval in the RI. There are two logically possible scenarios of what happens to that representation. One possibility is that cognitive load is low enough so that articulatory rehearsal and/or refreshing can fully compensate the adverse effect of decay, so that no net

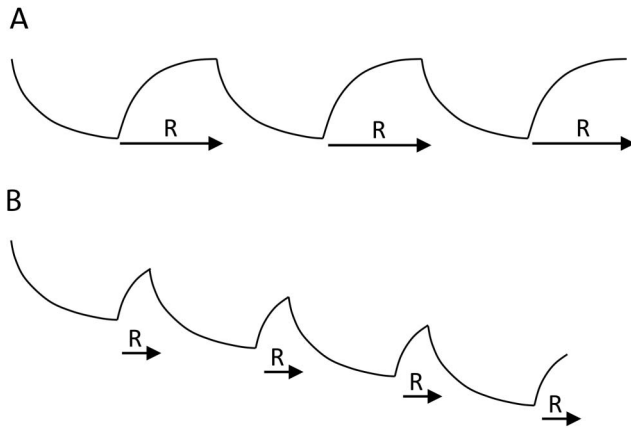

Figure 9. Schematic time line of memory strength of an item undergoing decay and refreshing. Strength is increased through refreshing (arrows marked with R) but declines through decay when central attention is engaged by another process (e.g., encoding or refreshing another item, or processing a distractor). (A) Low cognitive load, such that refreshing fully compensates decay. Memory strength does not decline over an increasing retention interval. (B) Higher cognitive load, such that refreshing only partly compensates decay. Memory strength declines over an increasing retention interval.

loss of memory strength occurs (Scenario A in Figure 9). Alternatively, cognitive load is high enough to prevent full compensatory restoration, implying a net loss of memory strength (Scenario B in Figure 9). Under the first scenario, memory accuracy can be maintained at a constant level regardless of the duration of the RI, whereas under the second scenario, the net loss of memory strength during any interval of the RI accumulates as the RI is increased, implying more forgetting over a longer RI. Now consider two levels of cognitive load, such that memory is worse at the higher level. The only way this effect of cognitive load can be explained within a decay theory is to assume that (at least) at the higher level of cognitive load, decay cannot be fully compensated by restoration (as in Scenario B). If both levels of cognitive load allowed full compensation of decay, memory would not differ between them. It follows that (at least) at the higher level of cognitive load, there must be a net loss of memory strength over any time interval in the RI. Therefore, at that level of cognitive load, a decay theory must predict that memory declines with longer RIs. The opposite has been observed, disconfirming a prediction from the decay hypothesis (Oberauer & Lewandowsky, 2014).

Visual and spatial memoranda. Whereas in the verbal domain the evidence against a role for decay in WM is strong, the picture is more ambiguous in the visual-spatial domain (B3). Turning first to *visual* information, several experiments on WM for visual features such as colors, orientations, or shapes have shown a decline of accuracy over unfilled RIs (Gold, Murray, Sekuler, Bennett, & Sekuler, 2005; Mercer & Duffy, 2015; Morey & Bieler, 2013; Pertzov, Bays, Joseph, & Husain, 2013; Ricker & Cowan, 2010; Sakai & Inui, 2002; Zhang & Luck, 2009), whereas others have not (Gorgoraptis, Catalao, Bays, & Husain, 2011; Kahana & Sekuler, 2002; Magnussen & Greenlee, 1999; Vogel, Woodman, & Luck, 2001).

Interpretation of these findings is further complicated by the fact that the experiments cited in the preceding paragraph did not

control for *temporal distinctiveness* of successive trials. Temporal distinctiveness refers to the discriminability of memories on the psychological time dimension. Distinctiveness models of memory, such as SIMPLE (G. D. A. Brown et al., 2007), assume that temporal distinctiveness of two events—such as the current trial and the preceding trial in an experiment—depends on the ratio of the time intervals that have passed since the two events. If the RI of a WM task is increased while the intertrial interval is held constant, the temporal distinctiveness of the current trial relative to the preceding trial is reduced, leading to more confusion between trials—that is, more proactive interference.

Effects of temporal distinctiveness can be separated from decay effects by varying both the RI and the intertrial interval (ITI). By choosing an appropriate ITI for each level of RI, temporal distinctiveness can be held constant across variations of RI (see Figure 10A). With this design, distinctiveness theories predict no effect of RI whereas decay theories predict that memory declines with increasing RI. Two recent studies testing WM for colors using this design have shown that memory performance varies with temporal distinctiveness, and the effect of RI disappears when distinctiveness is held constant (Shipstead & Engle, 2013; Souza & Oberauer, 2015). An effect of temporal distinctiveness was also observed for short-term recognition of complex visual stimuli (Mercer, 2014). A further study (Ricker, Spiegel, & Cowan, 2014) using arrays of unfamiliar characters or letters (with articulatory suppression) as memory materials obtained mixed evidence, with a strong effect of RI and an effect of ITI that was smaller, and nonsignificant in two out of four experiments, suggesting that there is an effect of decay in addition to an effect of proactive interference. Taken together, the evidence for decay of visual stimuli in WM is mixed, and whether or not decay plays a role might depend on the stimuli, the experimental parameters, and the procedure of testing, in as yet unknown ways (see Figure 10B).

A number of studies have observed that WM for *spatial locations* declines over unfilled RIs, but the decline is in most cases very shallow, amounting to negligible forgetting after 10 s or more (B3; Hole, 1996; Jones, Farrand, Stuart, & Morris, 1995; Parmentier & Jones, 2000; Phillips & Christie, 1977; Ploner, Gaymard, Rivaud, Agid, & Pierrot-Deseilligny, 1998). Again, these studies have not controlled temporal distinctiveness, so the small effect of RI could reflect distinctiveness rather than decay. One recent study has demonstrated substantial forgetting of spatial information over time while holding temporal distinctiveness constant, but only when the screen went blank during the RI, thereby removing environmental support for a hypothetical visual rehearsal process (Lilienthal et al., 2014). The substantial forgetting during RIs of 1 versus 4 s in Lilienthal et al. (2014) is difficult to reconcile with the negligible forgetting observed over even longer blank-screen RIs in other studies (e.g., Jones et al., 1995). The available experiments differ in many regards that could explain the highly variable effects of unfilled RI. One potentially relevant variable is the time available for consolidation of information in WM (Joliceur & Dell'Acqua, 1998; Nieuwenstein & Wyble, 2014). For instance, Jones et al. presented a set of dot locations sequentially for 2 s per dot, whereas Lilienthal et al. presented each dot for just 1 s. A study by Ricker and Cowan (2014) showed that the rate of forgetting over unfilled RIs was substantially diminished when more time was allowed for consolidation of information in WM, for instance by presenting items sequentially, or allowing more time

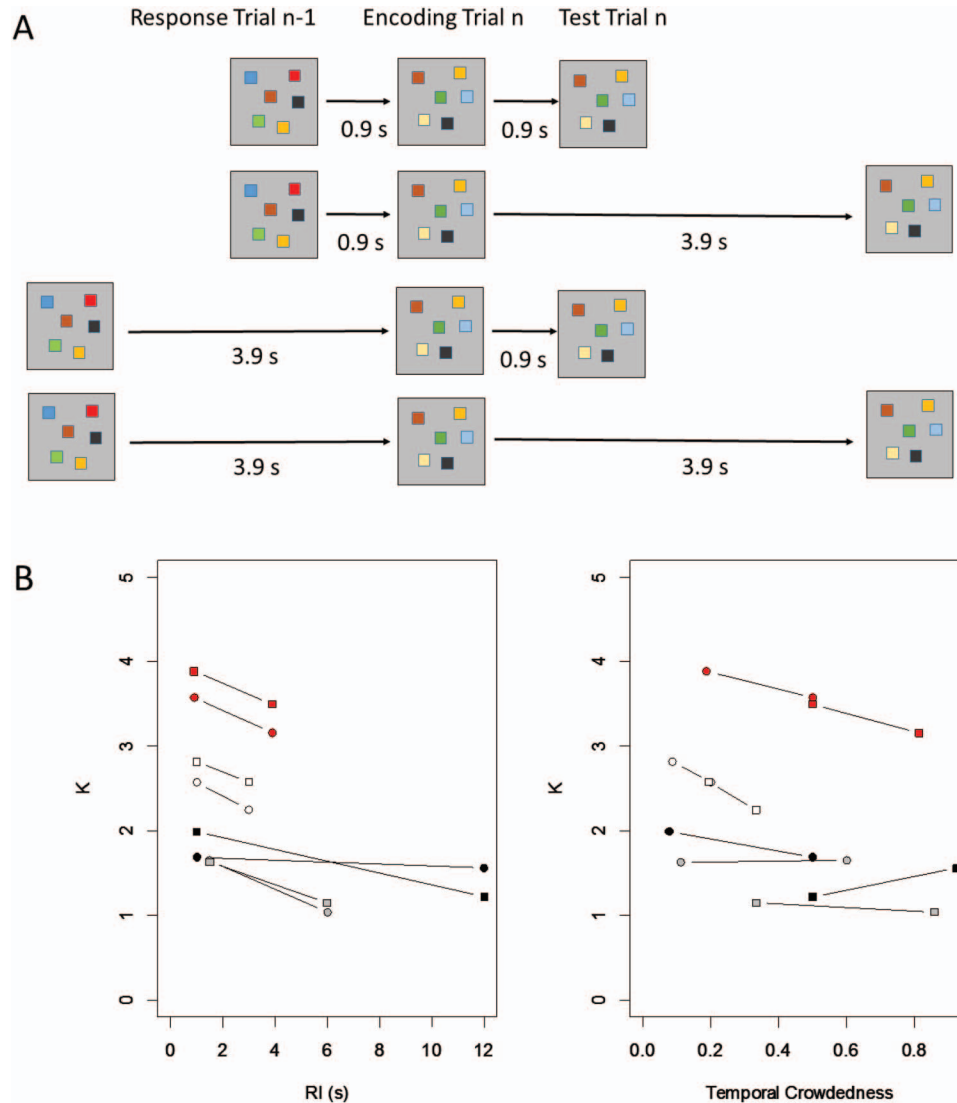

Figure 10. Effects of unfilled retention intervals (RI) and intertrial intervals (ITI) on working memory (WM) for visual materials (finding B3). (A) Design of the change-detection experiments of Shipstead and Engle (2013), varying the ITI (from response in the preceding trial to encoding of a new memory array in the current trial) and the RI (from encoding to onset of the test display in the current trial). Each row shows the time line of one condition; the conditions in rows 1 and 4 have equal temporal crowdedness (i.e., lack of distinctiveness), defined as $RI/(RI + ITI)$. (B) Memory performance, measured as Cowan's K , in four representative experiments varying RI and ITI, displayed as a function of RI (left) and of temporal crowdedness (right). Black and grey: Experiments 1 and 3 of Ricker et al. (2014), respectively; red: Experiment 4 of Shipstead and Engle (2013); white: Souza and Oberauer (2015). Within each study, circles reflect the short, and squares the long ITI condition. In all four experiments memory declined with longer RIs. In the experiments of Shipstead and Engle (2013), and of Souza and Oberauer (2015), but not those of Ricker and colleagues (2014), memory was better with longer ISIs, so that performance depended on temporal distinctiveness: Two conditions with different RIs but equated for temporal distinctiveness resulted in equal performance (see the two intermediate red and white data points in Panel B). See the online article for the color version of this figure.

for encoding a simultaneous array. This finding converges with the observation of Sakai and Inui (2002) that the rate of forgetting of visual features became more shallow as the presentation duration was increased from 120 to 1,200 ms. One interpretation of this result is that representations in WM need to be consolidated to

become immune to decay, and different materials might differ in the time it takes to consolidate them.

Few studies have investigated forgetting of visual or spatial memoranda as a function of the duration of an RI filled with distracting activity (B2). On the decay hypothesis, filling the RI

with distractor processing should impair restoration and, therefore, accelerate the decline of memory over time. Ricker and Cowan (2010) found change-detection accuracy to decline over an RI filled with mental arithmetic. The processing task impaired memory compared with a condition with unfilled RI, but did not lead to faster forgetting over time. Christie and Phillips (1979) asked participants to reproduce patterns of randomly filled grids after variable RIs during which they counted backward in steps of three. Distractor processing reduced memory compared to a condition with unfilled RI, but the duration of the RI had no effect. This result mirrors the findings of Oberauer and Lewandowsky (2013, 2014) using verbal memoranda combined with nonverbal distractor, which also found that memory was unaffected by the duration for which the distractor task had to be carried out. Neither of these findings matches the prediction from the decay hypothesis.

Cross-domain and domain-specific effects of distractor processing (B4–B6). The decay hypothesis has no problem explaining the finding that memory is impaired by processing of distractors in a different domain (B5). Cross-domain dual-task costs are to be expected if a domain-general attentional mechanism contributes to memory restoration (Vergauwe et al., 2010). The decay hypothesis can also explain domain-specific effects of processing on memory by assuming domain-specific rehearsal processes, such as articulatory rehearsal for verbal memoranda, and spatial shifts of attention for spatial memoranda (B4). The heterogeneity benefit, in contrast, is challenging for the decay hypothesis (B6): There is no reason why, for instance, memory for words should be impaired more by processing of words than of digits, whereas memory for digits is impaired more by processing of digits than of words: Processing of words and of digits should equally disrupt articulatory rehearsal.

Conclusion. Whereas the decay assumption offers viable explanations for some findings—in particular the effect of cognitive load, and the observation of both domain-general and domain-specific effects of distractor processing—it is challenged by others. The most problematic result is the lack of forgetting—at least of verbal information—over time, even when articulatory rehearsal, attention-based refreshing, or both are prevented by a concurrent processing task.

Resources

The resource assumption has often been invoked to explain why WM maintenance suffers from a processing task carried out during the RI: The processing task is assumed to take away part of the resource needed for maintenance, leaving less to be distributed among the memory items. This explanation, though intuitively appealing, is less straightforward than it appears. Assume that a memory set is encoded by dividing 100% of a resource among its items. In the subsequent RI 50% of the resource is demanded by a processing task. As a consequence, the resource share assigned to each item needs to be cut in half. Once the processing task is finished, it no longer requires any part of the resource, so the resource can be given back to the memory items. When memory is tested after the processing task is completed—as is usually the case in dual-task paradigms of WM—then the resource share allocated to each representation in WM at the time of test is not diminished by the fact that a processing task had to be completed in the RI. Therefore, models in which performance depends on the resource allocation at retrieval (e.g., Lovett, Reder, & Lebiere, 1999) do not explain the effect of concurrent processing as

arising from resource competition, because processing and retrieval never compete for resources.

A resource account of how processing during the RI impairs maintenance must make an additional assumption: Once the resource share of a representation in WM falls below a threshold, that representation is irreversibly forgotten, so that even when part of the resource is freed later, it cannot be reallocated to that representation. This is the assumption underlying the 3CAPS model (Just & Carpenter, 1992). In what follows we will discuss the resource hypothesis augmented with the *irreversibility assumption* above. Departing from the order of findings in Table 3, we postpone discussion of the effect of cognitive load (B1) because it is understood better in the context of more general considerations about the role of the intensity and duration of processing during a retention interval.

Retention interval and the amount of distractor processing: Intensity and duration (B2, B3). A processing task that demands more of the shared resource should impair memory to a larger degree. In this context it is important to consider two dimensions of the resource demand of a processing task, its *intensity* and its *duration*. According to the irreversibility assumption introduced above, the amount of forgetting caused by a concurrent processing task should depend on the intensity of that task's resource demand, not on its duration: A processing task that demands more of the resource share at any point in time leads to more serious resource cuts for the memory items, putting them at higher risk of being irreversibly forgotten at that moment (compare Scenarios A and C in Figure 11). As long as a processing task demands a constant share of the resource, its duration should not matter: Cutting the resource share of memory representations either pushes it below the retrieval threshold right away, leading to instant forgetting, or does not push it below the threshold, allowing indefinite maintenance (compare Scenarios A and B in Figure 11).

At first glance the prediction that processing duration does not matter appears attractive because it matches a large set of findings showing that, when the intensity of a concurrent processing demand is held constant, its duration has no impact on memory (B2). Speaking an irrelevant word or syllable aloud impairs memory for verbal lists, but it does not matter for how long the same utterance is repeated (Humphreys et al., 2010; Lewandowsky et al., 2010; Lewandowsky et al., 2008; Longoni et al., 1993; Oberauer & Lewandowsky, 2008; Phaf & Wolters, 1993; Vallar & Baddeley, 1982). Likewise, making simple binary decisions impairs serial recall of verbal lists, but the number of such decisions to be carried out at a constant rate has little impact on memory (Oberauer & Lewandowsky, 2008, 2014). Memory for spatial patterns is impaired by concurrent backward counting, but the duration of the backward counting has no effect (Christie & Phillips, 1979). As we noted above, these effects are problematic for the decay assumption, but they can be accommodated by the resource hypothesis.

There is, however, an equally solid body of evidence showing that under certain conditions the duration of concurrent processing has a substantial effect on memory. This is the case whenever the material processed varies over time (B2; see Figure 7): When people have to repeat the same distractor word several times, their memory performance is indistinguishable from that when required to say the word only once, but when people have to say several different words in between presentation of each memory item, list

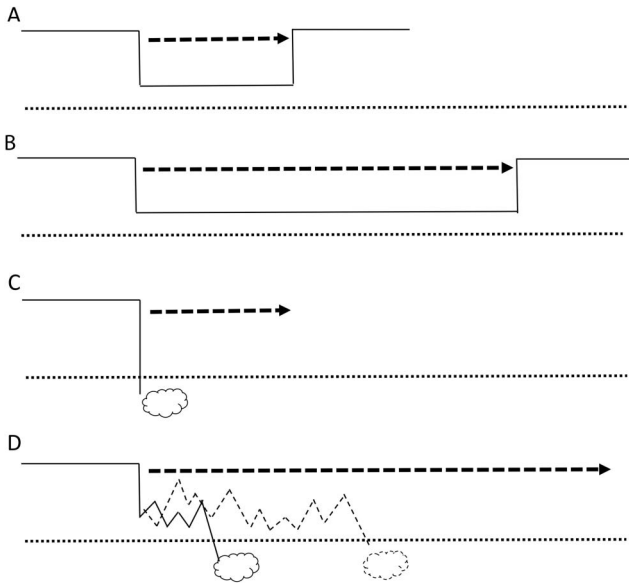

Figure 11. Schematic timeline of the resource share of a memory item when a distractor task temporarily draws away part of the resource from it. The continuous line shows the resource share of the memory representation over time (from left to right); the thick broken arrow covers the duration of the processing task, and the dotted line is the retrieval threshold, such that any representation falling below the threshold is irrevocably forgotten (symbolized by the evaporation cloud). (A) A short period of concurrent processing demand of low intensity in a model without random fluctuations of resource assignment. The memory item's resource share remains above threshold, and after the distractor task is completed, the full resource amount can be restored to the item. (B) Like A but with a longer period of distractor processing. The distractor task does no more harm to memory than in A. (C) A short period of high-intensity processing demand: The memory representation is instantly forgotten as the processing demand pushes its resource share below threshold. (D) An extended period of processing with low average resource demand but random fluctuation of resource assignment (a sample of two time courses is shown as the continuous and the broken line). As the processing period is extended, there are more chances of the item's resource share to fall below threshold, thereby being irrevocably forgotten.

recall is worse than when they have to say only a single word (Lewandowsky et al., 2010; Lewandowsky et al., 2008; McFarlane & Humphreys, 2012). Similarly, carrying out four arithmetic operations impairs memory more than two operations at the same rate (Gavens & Barrouillet, 2004).

An effect of the duration of processing could be accommodated in a resource model by assuming that the allocation of resource quantities, or the threshold, fluctuates randomly over time (Scenario D in Figure 11). Assume that an item in WM has its resource share curtailed by a concurrent processing task, but its mean resource share is still slightly above threshold. This item could survive in WM indefinitely if its resource share remained constant. This is not the case, however, if the resource share fluctuates over time, and the item is irrevocably forgotten if its resource share at any point in time falls below a threshold. The chance that the resource share falls below the threshold at least once during a time interval increases with the duration of the interval. Therefore, a longer duration of a resource-demanding processing task should lead to more forgetting.

This version of the resource model comes down to a resource-modulated decay model: The chance of irreversibly forgetting any memory item increases over time, and the rate of forgetting depends on the mean resource share of that item during the time interval in question. This version of resource theory runs into the same difficulties as the decay hypothesis: It cannot explain why processing duration does *not* matter when the material processed has low variability (e.g., a series of binary decisions on highly similar stimuli).

Cognitive load (B1). The resource hypothesis also offers no obvious way to explain the cognitive-load effect (B1). When cognitive load is maximal, the entire available time for a processing task is required for processing, implying that any resource amount needed for the processing task is continuously engaged by it. Cognitive load can be reduced by reducing the pace of processing, thereby adding free time in between individual processing steps—during these intervals the resource is presumably not needed for processing. Yet, there is no way in which this intermittently free resource could benefit memory: The free resource could be allocated to memory representations for a short time but will soon be claimed back by concurrent processing demands, leaving the memory representation as resource-depleted as before.

Perhaps the cognitive-load effect arises from a resource limit because higher cognitive load increases the intensity of processing, such that the processing task recruits a larger proportion of the resource. This is conceivable because cognitive load has often been manipulated through a variation of time pressure (e.g., Barrouillet et al., 2007), and a resource-based system should respond to time pressure by speeding up processing steps through allocating a larger resource share to them (Tombu & Jolicoeur, 2003). Two findings speak against that possibility, though. First, when time pressure for distractor processing in a complex-span task is increased, people do not increase the efficiency of distractor processing (i.e., produce equally accurate responses at higher speed) but rather trade accuracy for speed (Oberauer & Lewandowsky, 2013). Other studies on time pressure found that time pressure even decreased processing efficiency (Dambacher & Hübner, 2015). Second, the effect of cognitive load is also observed in the absence of time pressure: In the experiments of Oberauer, Lewandowsky et al. (2012) participants were free to complete each processing step when they were ready, and cognitive load was manipulated by varying the free time between a response and the next stimulus. Memory was again better at lower cognitive load. The cognitive-load effect is to a large part a beneficial effect of free time in between distractor processing, and a resource account has no way to explain that effect.

It might be tempting to explain the cognitive-load effect by assuming that the resource is needed for refreshing items, or to otherwise protect them from decay. The longer a distractor task captures some of the resource, the longer memory representations are left to decay. This is essentially the explanation of the cognitive-load effect given in the time-based resource-sharing (TBRS) model (Barrouillet et al., 2004). This approach implies that decay, not a resource limit, is the primary cause of the capacity limit. The resource limit comes into play only as limiting the

restoration process that mitigates decay. Therefore, we discussed this account above in the Decay section of Round B.

Cross-domain and domain-specific effects of distractor processing (B4–B6). The resource-based explanation of dual-task costs in WM implies that a concurrent processing task should impair memory if processing and maintenance compete for the same resource. If a domain-general resource is assumed, then processing requirements with very little similarity or overlap with the memory contents should disrupt maintenance. There is substantial evidence supporting this prediction (B5). At the same time, processing tasks using material from the same broad content domain (verbal vs. visual or spatial) have often been found to impair memory more than processing tasks from a different domain (B4). These findings can be jointly explained by assuming that WM draws on a general resource together with domain-specific resources (Baddeley, 1986; Logie, 2011).

More problematic for the resource hypothesis are findings showing smaller dual-task costs when memoranda and processing materials come from different categories within the same content domain (B6). Explaining this heterogeneity benefit by assuming separate resources for different categories within a domain, such as digits, words, and nonwords, would open the door to a boundless inflation of resources, rendering the resource theory untestable.

Conclusion. The hypothesis of a domain-general resource, embellished with appropriate assumptions, provides an attractive explanation for why WM maintenance is often found to be impaired by an unrelated processing task even when it has no obvious overlap with the memory contents. The resource hypothesis struggles, however, with explaining why the effect of processing on maintenance depends on whether memoranda and processed material come from the same class of stimuli within a domain; why the duration of processing has an impact on memory if and only if the processed material varies over time; and why it is beneficial for memory if a concurrent processing episode is interspersed with longer intervals of free time.

Interference

Interference theories can account for the adverse effect of distractor processing on memory by assuming that the representations engaged in processing enter WM and, therefore, interfere with representations of memory items (Saito & Miyake, 2004).

Cognitive load (B1). The effect of cognitive load (B1) poses a problem for interference theories, because it is not immediately obvious how low cognitive load—that is, more free time in between individual operations on a distractor task—should be beneficial for memory. One suggested solution is that the free time is used to “remove” representations of previously processed distractors from WM, by unbinding them from their encoding context, thereby reducing interference with the memoranda (Oberauer, Lewandowsky, et al., 2012). Every theory of WM must assume some process by which WM is cleared of no-longer relevant representations. If this does not happen on its own through decay, it has to be accomplished by some other process, such as unbinding or removal.

Independent evidence for the selective removal of no-longer relevant information from WM comes from three sources. One is the recency effect in immediate serial recall: The last few list items are usually recalled better than the preceding ones. Most models of

serial recall attribute this recency effect at least in part to response suppression: Once a list item is recalled, it is removed from WM so that it does not interfere with recall of subsequent items. As recall nears the end of the list, there are only few items left in WM, reducing interference for the last list items. In line with this explanation, the recency effect is larger if all list items up to the last have been recalled—even though in the wrong order—compared with trials on which people failed to recall some precency items (Farrell & Lewandowsky, 2012). A second line of evidence comes from research on WM updating: When a precue indicates a specific list item as the one to be replaced on the next updating step, people can remove that item from WM before seeing the replacement stimulus (Ecker, Oberauer, & Lewandowsky, 2014; Ecker, Lewandowsky, & Oberauer, 2014). Finally, research from visual WM suggests that when one item, or a subset of items, is cued during the RI as relevant, other items can be removed from WM (Souza, Rerko, & Oberauer, 2014; Williams, Hong, Kang, Carlisle, & Woodman, 2013).

The strong theoretical reasons for assuming that outdated representations can be selectively removed from WM, together with the empirical evidence supporting this assumption, suggest an explanation for the cognitive-load effect: Lower cognitive load implies more free time in between processing of distractors, and that time can be used to remove distractors, thereby reducing interference. Oberauer, Lewandowsky et al. (2012) have implemented this idea in one interference model of WM, SOB-CS. In SOB-CS, every distractor is bound to the context in which it is encountered, and when processing is complete that distractor is unbound from its context. The mechanism by which unbinding takes place is identical to that which accomplishes response suppression during recall. Oberauer, Lewandowsky et al. (2012) showed that with the inclusion of this unbinding process, SOB-CS produces the linear effect of cognitive load on memory performance.

Retention interval and the amount of distractor processing (B2, B3). The interference hypothesis makes a specific prediction for the effect of distractor processing in the RI: The degree to which memory is impaired should not depend on the duration of a distractor-filled RI, but on the number of *different* representations engaged during distractor processing: With every new distractor, a new representation enters WM and adds to the interference suffered by the memoranda. For instance, if the distractor task consists of reading aloud words, the amount of interference should depend on the number of different words read. This prediction has been confirmed (B2): When participants have to speak the same word or syllable repeatedly during maintenance of a verbal list, forgetting does not depend on how often they repeat the utterance. In contrast, if they have to say aloud a series of different words, memory is impaired more the more words need to be spoken (Lewandowsky et al., 2010; Lewandowsky et al., 2008; McFarlane & Humphreys, 2012).

As already noted, interference is instantaneous, and therefore, the interference hypothesis does not predict forgetting over an unfilled RI. A decline of memory with increasing unfilled delays could be explained only through temporal distinctiveness: If the RI is increased while the ITI is held constant, temporal distinctiveness of the trials is decreased, making it harder to distinguish the current memory set from that of preceding trials, thereby increasing the risk of proactive interference (Shipstead & Engle, 2013). It follows that the interference hypothesis is challenged by findings of grad-

ual memory loss over an unfilled RI when temporal distinctiveness is controlled through a concomitant variation of the intertrial interval (B3; Lilienthal et al., 2014; Ricker et al., 2014). One potential explanation for these findings within an interference framework is that participants generated representations during the RI spontaneously through mind wandering, which often involves visual images (Teasdale, Proctor, Lloyd, & Baddeley, 1993) that could interfere with visual memoranda, or through erratic eye movements that are known to interfere with spatial WM (Pearson & Sahraie, 2003). In the absence of independent evidence of such self-generated representations, however, such an explanation is post hoc and therefore unsatisfying.

Cross-domain and domain-specific effects of distractor processing (B4–B6). Interference from distractor processing should depend on the similarity and the feature-space overlap between memoranda and distractors. The predicted pattern of these effects has been explored through simulations with SOB-CS (Oberauer, Lewandowsky, et al., 2012), and can be summarized as follows.

First, if the distractors come from the same category as the memory items (e.g., both are sets of words), so that they cannot easily be distinguished by a category difference, distractors tend to be confused with items, leading to an above-chance rate of intrusions of distractors in recall. Distractor intrusions become more prevalent when the similarity between items and distractors within a class of stimuli (e.g., words) is increased. At the same time, distractors more similar to memory items create less interference by superposition, reducing the prevalence of other kinds of errors (i.e., transpositions, other extralist intrusions). Both of these predicted effects have been confirmed experimentally (Oberauer, Farrell, et al., 2012): When distractors were made similar to the immediately preceding memory items, people were more likely to recall the correct item, but when they did make an error, they were more likely to confuse the item with the following (similar) distractor, compared with a condition where distractors were dissimilar to all items.

Second, when distractors come from a different category than the memoranda within the same content domain (e.g., letters and digits), interference by confusion is minimal, so that the detrimental effect of processing on memory is less severe than when distractors come from the same category. This prediction is borne out by the heterogeneity benefit (B6; Conlin & Gathercole, 2006; Conlin et al., 2005; Li, 1999; Turner & Engle, 1989; but see Macken & Jones, 1995).

Third, when the distractors come from a different domain than the memoranda (e.g., verbal vs. spatial), interference is reduced compared to distractors from the same domain because contents from different domains have less feature-space overlap, reducing interference by superposition (as well as interference by feature overwriting). This prediction has also been confirmed (B4; Chein et al., 2011; Davis et al., 2013; Hale et al., 1996; Jarrold et al., 2011).

Several studies have found impairment of maintenance by processing of materials in a different domain, compared with a no-processing control condition (B5; e.g., Chein et al., 2011; Jarrold et al., 2011). An interference account can explain these findings by assuming that distractor processing engages not only representations of the stimuli to be processed but also of the responses, the task set, and perhaps of executive control settings. Even if there is no feature-space overlap between the memoranda and the distractor stimuli, there is arguably feature-space overlap between the memoranda and other representations involved in the processing

task (Oberauer, Lewandowsky, et al., 2012). Such an explanation remains preliminary until the representations actually involved in a given distractor processing task are determined independently of their effect on memory. Therefore, we argue that the interference hypothesis is consistent with finding B5, but does not yet offer a satisfactory explanation of it.

Conclusion. To summarize, two mechanisms of interference—interference by confusion and by superposition—jointly provide an accurate account of the detailed pattern of dual-task costs between maintenance and concurrent processing. Yet, for a complete account of effects of unfilled retention intervals and of dual-task costs across different domains, an interference model has to make as yet untested assumptions about the recruitment of representations that do not correspond directly to information given in the environment.

Round B: Summary

Round B favored the interference hypothesis, which correctly predicted three findings (see Table 3): The fact that the duration of distractor processing depends on the variability of distractors (B2), the finding that impairment of memory by processing is reduced when distractors come from a different domain than the memoranda (B4), and the fact that it is also reduced when they come from a different class of stimuli (B6). The resource hypothesis predicts only one finding, the cross-domain impairment of memory by processing (B5), and the decay hypothesis predicts none. Conversely, both the decay and the resource hypothesis are challenged by two findings (B2, B6), and the resource hypothesis faces the additional problem of being difficult to reconcile with the cognitive-load effect (B1). The interference hypothesis is challenged by only one finding: the loss of memory over unfilled retention intervals for some visual and spatial memoranda (B3).

Round C: Individual Differences

Correlations of measures of WM capacity with other variables can be used to test hypotheses about what *causes* the capacity limit: Whereas a positive correlation between WM capacity and a putative cause—for instance, processing speed—does not imply causation, the absence of such a correlation seriously challenges the hypothetical causal link (Underwood, 1975). Conversely, correlational data can also serve to explore the *scope* of the WM capacity limit, asking which cognitive functions and processes are limited to what extent by that capacity limit. The following five findings from individual-differences research, summarized in Table 4, qualify as diagnostic because they speak either to potential causes or to the scope of WM capacity, or both.

First, there is the hierarchical factorial structure of WM capacity tests, which has been consistently obtained across studies that used a broad set of WM tests (Table 4, C1): WM capacity is a notably general source of variance between individuals, as shown by the fact that a large variety of tasks used to measure it load strongly on a common factor (Kane et al., 2004; Wilhelm, Hildebrandt, & Oberauer, 2013). Yet, on a lower level of generality, separate factors for verbal-numerical and for visual-spatial WM tasks can be distinguished (Alloway, Gathercole, & Pickering, 2006; Kane et al., 2004; Oberauer et al., 2000; Shah & Miyake, 1996). Figure 12 shows results from

Table 4
Summary of Informative Findings and Evaluations of Hypotheses in Round C: Individual Differences

Index	Finding	Decay	Resource	Interference
C1	The factorial structure of WM tasks includes a general factor of WM capacity (C1a) together with domain-specific factors for verbal-numerical and for visual-spatial WM (C1b)	+	++	+
C2	WM capacity correlates with processing speed, in particular with the drift-rate parameter of the diffusion model of response-time distributions from speeded choice tasks	++	+	0
C3	WM capacity correlates with measures of long-term memory	+	+	+
C4	WM capacity correlates with resistance to distraction in attention tasks	-	+	+
C5	Some valid measures of WM capacity involve no memory requirement	-	++	++

Note. Table entries reflect our judgment of the logical relation between a finding and a hypothesis: The hypothesis predicts (++) or can explain (+) the finding, it is consistent with the finding (0) or it is challenged by the finding (-); see text for explanation. WM = working memory.

a representative study illustrating the generality and the domain-specificity of individual differences in WM capacity. Second, WM capacity is correlated with speed on simple tasks, in particular with the efficiency of information processing in speeded choice tasks (C2; Ratcliff, Thapar, & McKoon, 2010; Schmiedek, Oberauer, Wilhelm, Süß, & Wittmann, 2007; see Figure 13). Third, WM capacity has been found to be highly correlated with measures of episodic long-term memory (C3; Unsworth, 2010; Unsworth, Brewer, & Spillers, 2009).

Our remaining two diagnostic findings pertain to the relation between WM capacity and attention. These last two findings, C4 and C5, further underscore that the scope of WM extends beyond tests of immediate memory. The fourth finding is that measures of WM capacity are positively correlated with indicators of the suc-

cess in overcoming distraction in simple attentional paradigms (C4), such as the antisaccade task (Chuderski, 2014; Shipstead, Lindsey, Marshall, & Engle, 2014), the Stroop task (Kane & Engle, 2003; Meier & Kane, 2013), the flanker task (Heitz & Engle, 2007; but see Keye, Wilhelm, Oberauer, & van Ravenzwaaij, 2009), and the prevalence of self-reported task-unrelated thoughts (McVay & Kane, 2009, 2012). Examples of frequently used paradigms for measuring controlled attention are given in Figure 14.

The fifth diagnostic finding concerns simultaneous attention to multiple elements and their relations: Tests of WM capacity based on short-term recall, such as complex-span tasks, correlate highly with performance on *relational-integration* tests (C5; Oberauer, Süß, Wilhelm, & Wittmann, 2003). In these tasks, people monitor

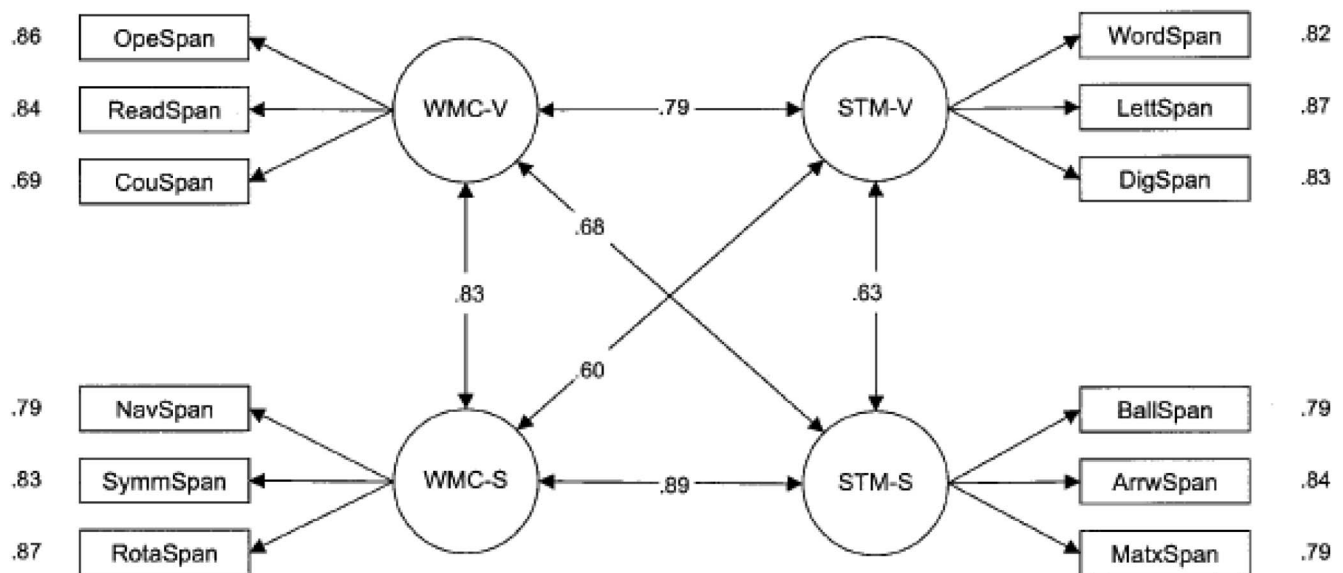

Figure 12. Structural equation model of simple span tasks (STM) and complex span tasks (WMC) with verbal (V) and spatial (S) memoranda, reproduced from The generality of working-memory capacity: A latent-variable approach to verbal and visuo-spatial memory span and reasoning. Kane, M. J., Hambrick, D. Z., Tuholski, S. W., Wilhelm, O., Payne, T. W., & Engle, R. W. (2004). *Journal of Experimental Psychology: General*, 133 (p. 203). Copyright 2004 by the American Psychological Association. Squares show manifest variables (i.e., measured scores), and circles show latent variables (i.e., factors). Factors representing working memory (WM) capacity in different domains (verbal vs. spatial) are distinct, but highly correlated, reflecting a substantial proportion of general variance shared among them (finding C1).

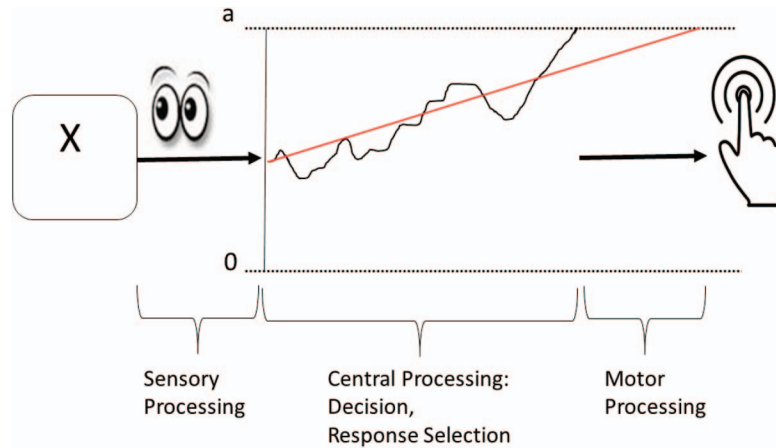

Figure 13. Components of response time in the diffusion model (Ratcliff, 1978). The sensory stage involves stimulus processing and categorization. The central processing stage involves making a decision to select one of two responses (e.g., whether the stimulus is a consonant or a vowel). The third stage involves motor execution (e.g., pressing a button). The central stage is modeled as the accumulation of evidence by a diffusion process that drifts toward one of two boundaries (dotted horizontal lines), representing the two response options. A decision is made once a boundary is reached. The diffusion process on each trial is noisy (black line); its efficiency is reflected by its average drift rate (slope of the red line). Estimates of the drift rate were found to correlate highly with working memory capacity (finding C2; Ratcliff et al., 2010; Schmiedek et al., 2007). See the online article for the color version of this figure.

a continuously changing array of visual stimuli to detect any instance in which a subset of the stimuli have a certain relation to each other (e.g., four dots forming a square, or two airplanes being on a collision course; see Figure 15 for examples). We regard this finding as diagnostic because it demonstrates that WM capacity is not merely a limit on how much information we can *remember* over a short period of time, but also on how much information in the environment we can simultaneously *attend to* and integrate. We next examine how each of the three theoretical contenders handles findings C1 to C5.

Decay

Factorial structure of WM (C1). How does the decay hypothesis fare in light of correlational findings concerning WM capacity? The strong general factor reflecting the common variance of WM tests across different domains and paradigms (C1a) could be explained as reflecting individual differences in the general decay rate, or in the efficiency of attention-based refreshing. The domain-specific factors (C1b) could be attributed to the efficiency of domain-specific forms of rehearsal such as articulatory rehearsal for verbal materials, and rehearsal of spatial information through deployment of spatial attention. The explanation of variability in WM capacity by variability in the speed of restoration flows directly from Jensen's "limited-capacity trace-decay theory" (Jensen, 1988). Jensen assumed that individual differences in WM capacity arise from differences in the speed of rehearsal. Analogous arguments have been applied to developmental differences: Kail (1992) has proposed that as children grow older, their general processing speed increases, which enables them to rehearse faster, leading to better WM capacity (see also Gaillard, Barrouillet, Jarrold, & Camos, 2011). Salthouse (1996) has proposed that the steep decline of WM capacity in old age is to a large

part because of the general slowing of information processing in old age, which in turn slows rehearsal of WM contents, leading to a larger net loss through decay. Here we extend this argument to the two forms of restoration proposed in contemporary decay theories: Individual and age-related variability in the speed of domain-general attentional refreshing could explain the general factor of WM, whereas variability in articulatory rehearsal and spatial rehearsal could explain the domain-specific factors of verbal and visual-spatial WM, respectively.

Correlations with processing speed and articulation rate (C2). One prediction following from the above assumptions is that independent measures of the efficiency of restoration processes should correlate with measures of WM capacity. Evidence speaking to this prediction is available from two sources. The first is the correlation between measures of WM capacity and indicators of the speed of attention-based refreshing (C2). Refreshing is assumed to be limited by the central attentional bottleneck (Barrouillet et al., 2007). The speed of central processes in simple decision tasks, which require the central bottleneck, is reflected in the drift rate of the diffusion model of choice RTs (Sigman & Dehaene, 2005). The drift rate in turn is highly correlated with WM capacity (Schmiedek et al., 2007). Moreover, Lee and Chabris (2013) demonstrated a direct relationship between the processing speed of the central bottleneck and fluid intelligence. These findings lend credibility to the idea that WM capacity reflects to a substantial degree the efficiency of attention-based refreshing.

The second line of evidence pertains to the efficiency of articulatory rehearsal. Researchers have measured how long people take to articulate verbal materials aloud as an indicator of their rehearsal speed, and used this measure as a predictor of performance on verbal serial recall. Earlier work found a positive cor-

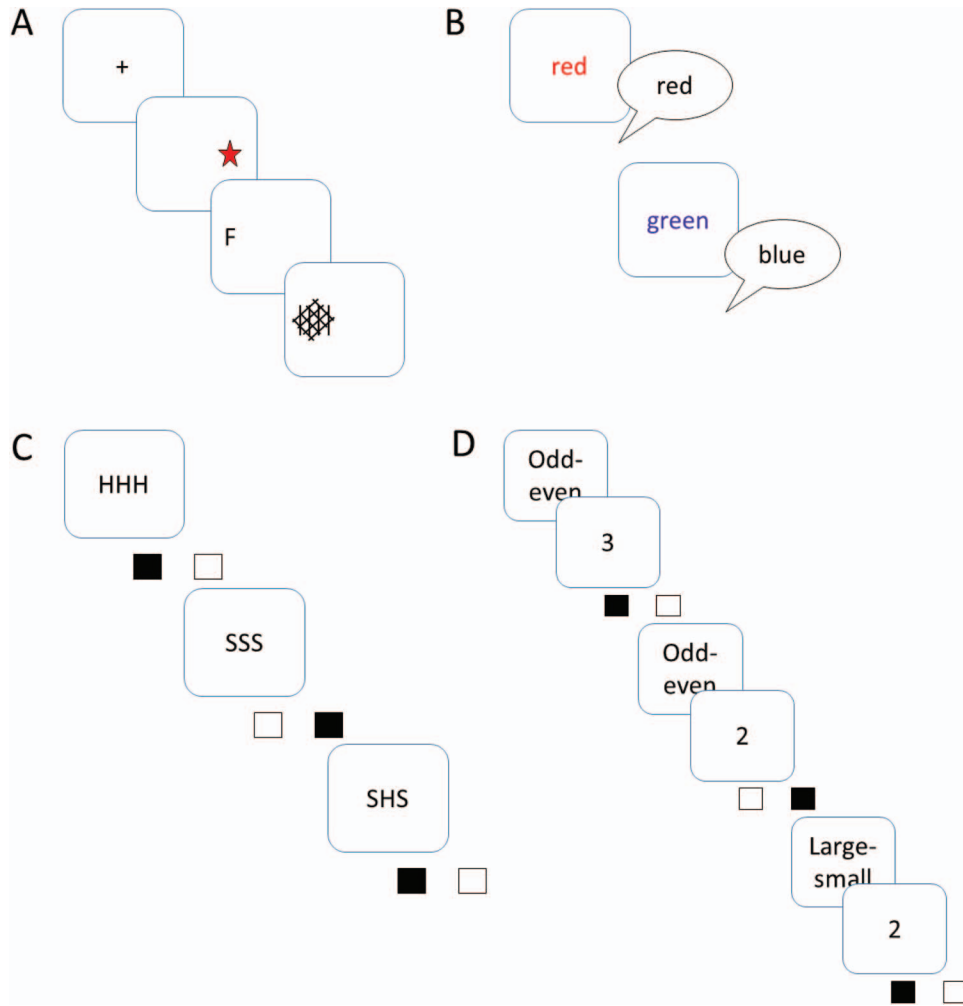

Figure 14. Example trials of tasks for measuring controlled attention (finding C4). (A) Antisaccade task: Participants must direct their gaze in the opposite direction of a flashing light to identify a stimulus presented briefly and then masked. Controlled attention is measured by identification accuracy. (B) Stroop task: Participants must name the print color as quickly as possible. The first stimulus shows a congruent trial on which the word matches the print color; the second an incongruent trial on which word and color mismatch. Controlled attention is measured by the size of the congruency effect. (C) Flanker task. Participants make a speeded classification for H and the right key for S), trying to ignore the flanking stimuli, which can be congruent (first and second trial) or incongruent (third trial). Controlled attention is measured as the size of the congruency effect. (D) Task-switch paradigm: Participants make speeded classification on digits according to one of two task rules, indicated by a task cue preceding each trial. The task switch cost is the difference between performance on trials requiring a task switch relative to the preceding trial and performance on task-repetition trials. The congruency cost is the performance difference between trials in which both tasks would require the same response and trials in which they would require different responses. See the online article for the color version of this figure.

relation between articulation rate and serial recall performance (e.g., Cowan et al., 1998; Kail, 1997). When controlling for the availability of verbal representations in long-term memory, such as the speed of lexical access (Tehan, Fogarty, & Ryan, 2004; Tehan & Lalor, 2000) or vocabulary (Ferguson & Bowey, 2005); however, measures of rehearsal speed did not account for significant variance in serial recall. These findings suggest that individual differences in lexical knowledge are a common cause of speed of lexical access, speed of articulation, and verbal serial recall. They

provide no evidence that the speed of articulatory rehearsal has a direct causal link to people's performance on verbal WM tasks.

Correlations with long-term memory (C3). We are not aware of any attempt to apply a decay theory to explain the correlation between WM and long-term memory (C3), but we envision two ways in which such an explanation could be worked out. One approach is to explain individual differences in WM capacity as arising from differences in the speed and effectiveness of rehearsal or refreshing. These restoration processes can

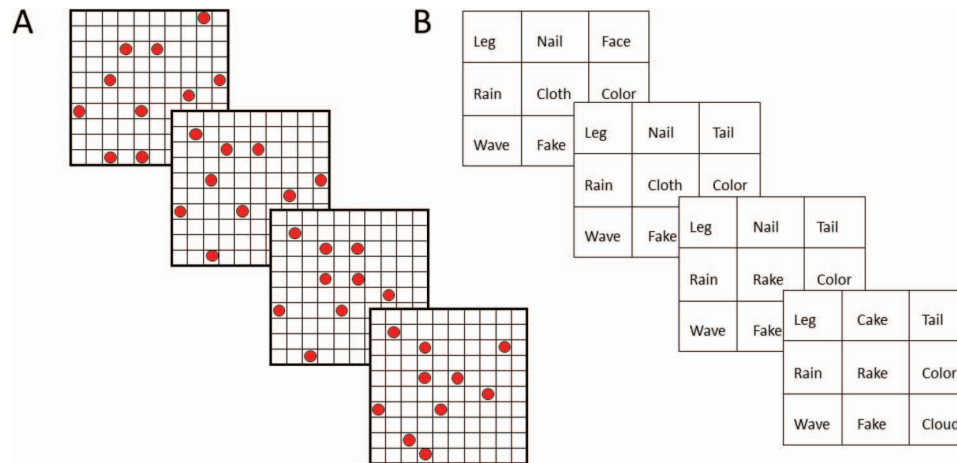

Figure 15. Example trials of two relational-integration tasks (Oberauer et al., 2003). (A) Finding-squares task: From each display to the next, two dots change location at random. Participants must detect when four dots in a display form a square. (B) Verbal monitoring task: From each display to the next one word is exchanged by a new word. Participants must detect when three words in a row, in a column, or across a diagonal rhyme with each other. These tasks are valid indicators of working memory (WM) capacity—they load highly on a WM capacity factor—although they do not require retention of information across a retention interval (finding C5). See the online article for the color version of this figure.

be argued to not only protect representations in WM from decay but to also help establishing long-term memory traces. Whereas articulatory maintenance rehearsal has only a limited effect on long-term memory (Greene, 1987), refreshing has been shown to improve long-term retention (Raye et al., 2007), and providing more time for refreshing during a WM task results in better recall of the memoranda in a delayed test (Camos & Portrat, 2015; Loaiza & McCabe, 2012b). Therefore, the efficiency of refreshing could be a source of common variance of WM and long-term memory. In line with this hypothesis, Loaiza and McCabe (2013) have argued that age differences in episodic long-term memory can in part be explained by age differences in the efficiency of refreshing.

The second approach starts from the assumption that individual differences in decay rate (perhaps in conjunction with differences in restoration processes) determine how much information can be maintained in WM simultaneously, which in turn determines the size of structures or chunks that can be formed and encoded into long-term memory. More complex elaborations and larger chunks arguably improve memory over the long term, and this could explain why people with higher WM capacity measures tend to do better on tests of long-term memory as well. To conclude, although the decay hypothesis does not directly predict the correlation between WM capacity and episodic long-term memory, it has no difficulty explaining it.

Correlations with measures of attention (C4, C5). In contrast, decay-rehearsal theories do have difficulties explaining the correlation of WM capacity with indicators of attentional control (C4), such as Stroop interference or performance in the antisaccade task (Kane, Conway, Hambrick, & Engle, 2007). To the best of our knowledge, no attempt has been made to explain the correlation between WM capacity and measures of attention or cognitive control in terms of decay and restoration. One potential explana-

tion could build on the hypothesis that representations of task goals or task sets implementing the instructions decay over time (Altmann & Gray, 2002). Individual differences in many indicators of attentional control can be attributed to failures of goal maintenance (Kane et al., 2007; Kane & Engle, 2003), which in turn could be attributed to decay.

There is scant evidence, however, that representations of task goals or task sets in WM decay over time. Altmann and Gray (2002) based their hypothesis of task-set decay on the observation of a gradual increase of response times over successive repetitions of the same task in a task-switch paradigm. Subsequent work, however, showed that this gradual slowing arises not from decay, but from people's growing expectation of a task switch: When participants know the number of task repetitions before the next task switch, they anticipate the switch and slow down in preparation for it; in contrast, when the number of task repetitions is unpredictable, no such slowing is observed (Monsell, Sumner, & Waters, 2003). Additional evidence against decay of task sets comes from another finding from the task-switch paradigm: When switching between three tasks, participants are slower to switch back to a task that they have carried out two trials ago than to a task that they last carried out longer ago (Mayr & Keele, 2000; for a review see Koch, Gade, Schuch, & Philipp, 2010). This is the opposite of what would be predicted from task-set decay. Moreover, Horoufchin, Philipp, and Koch (2011) have shown that the effects of varying the time between successive tasks, which have been attributed to task-set decay in earlier work, are better explained by temporal distinctiveness than by trace decay. In summary, the evidence consistently goes against the assumption that task representations decay, leaving little room for a decay-based explanation for the correlation between WM capacity and performance in attention-control tasks.

We close this section by considering a further prediction from a decay account for individual differences: A valid test of WM

capacity must require maintenance over a nonnegligible RI during which individual differences in decay rate and in the efficiency of restoration processes could influence performance. This prediction has not been borne out empirically (C5). WM capacity can be measured by a monitoring paradigm that requires no maintenance of information over any RI because all necessary information is continuously visible (Oberauer et al., 2003): People watch a changing set of stimuli and are asked to detect when a target constellation occurs among any subset of stimuli, such as a square among a subset of dots, or a row or column of rhyming words in a matrix (see Figure 15). This paradigm is among the most valid indicators of WM capacity, judged by its loadings on a general WM capacity factor, and among the best predictors of fluid intelligence (Buehner, Krumm, & Pick, 2005; Buehner, Krumm, Ziegler, & Pluecken, 2006; Chuderski, 2014; Chuderski, Taraday, Necka, & Smoleń, 2012; Oberauer, Süß, Wilhelm, & Wittmann, 2008). Individual differences in a task without an RI cannot be explained by differences in decay rate or efficiency of restoration processes; therefore, these findings render it highly unlikely that those variables contribute substantially to explaining individual differences in general WM capacity.

Conclusion. The decay hypothesis provides a satisfactory explanation for the factorial structure of WM capacity, and its correlation with processing speed and episodic long-term memory. It is challenged, however, by the correlation of WM capacity with performance on tasks that place little, if any, demand on the maintenance of information over time, such as attention-control tasks and perceptual monitoring tasks.

Resources

The notion of resources has often been invoked to explain the pattern of correlations of WM tests with each other and with other variables: When performance in two tasks is positively correlated, researchers routinely assume that they draw in part on the same resource. Factor analytic findings are interpreted by assuming that each factor stands for a resource. Often these interpretations are merely redescrptions of the findings, because identifying each factor with a resource does not explain why the correlational patterns underlying the factor structure are the way they are—any other factor structure could equally be interpreted in terms of resources. Resource accounts of individual differences gain explanatory value if a resource theory places constraints on the resources assumed to exist, so that predictions for the factor structure can be made.

Factorial structure of WM (C1). As discussed in the preceding two rounds, the findings of both domain-general and domain-specific set-size effects, and effects of distractor processing on memory, require the assumption of a domain-general resource together with domain-specific resources for verbal and for visual-spatial materials. This set of assumptions matches well with the WM model of Baddeley (Alloway et al., 2006; Baddeley, 2001, 2012), and it directly predicts the factor structure of WM capacity measures (C1).

Correlations with processing speed and long-term memory (C2, C3). The resource account also offers an explanation for the correlation of WM capacity and processing efficiency on simple speeded tasks, as reflected in the drift rate of the diffusion model (C2). The drift rate has been shown to reflect the speed of central

processes such as response selection (Sigman & Dehaene, 2006), which are constrained by a domain-general capacity limit. This capacity limit has been modelled as a resource limit (Navon & Miller, 2002; Tombu & Jolicoeur, 2003). Hence it would not be far-fetched to identify that resource with the resource underlying WM capacity.

We are not aware of a proposal for explaining the correlation between WM and episodic long-term memory (C3) within a resource theory. One approach could be formulated in analogy to a decay-based account sketched above: Individuals with more WM maintenance resources can hold larger sets of items available simultaneously, enabling them to form larger chunks and more elaborate structures to be encoded into long-term memory. Another approach could start from the assumption that retrieval from long-term memory depends on the same resource as maintenance in, or retrieval from, WM. This notion could be justified with the fact that retrieval from long-term memory is susceptible to dual-task interference (Carrier & Pashler, 1995; Rohrer & Pashler, 2003), and it would provide a natural link between the resource hypothesis and recent theoretical developments by Unsworth and Engle (2007). We conclude that the correlation between WM and long-term memory measures does not pose a fundamental challenge for resource theories.

Correlations with measures of attention (C4, C5). The resource assumption can also explain why WM capacity measures are correlated to several measures of attention (C4). Attention is often characterized as a limited resource, and if that resource overlaps with or is identical to the resource underlying WM capacity, their positive correlation follows as a necessary prediction. At the same time, assuming a general resource that fuels not only maintenance in WM but also various attentional functions risks diluting the resource concept to a point where it is little more than a redescription of the correlational findings. For such a concept to become testable it would be necessary to specify what the resource does in each of the attentional paradigms in which it is deemed relevant, that is, to characterize its performance-resource functions for those attentional paradigms. Combined with such specifications, the resource hypothesis would probably not predict that WM capacity correlates with every measure of attentional function to the same degree, but would rather predict correlations specifically with variables sensitive to the shared resource.

For instance, it could be argued that the resource underlying WM capacity is needed to maintain a strong representation of a task goal to avoid goal neglect. Goal neglect refers to the failure to implement a goal despite knowing and being committed to that goal. For instance, participants in a Stroop experiment (Figure 14 B) occasionally read the color word instead of reporting its print color, despite knowing that they were supposed to do the latter, and individuals with lower WM capacity commit this kind of error more frequently (Kane & Engle, 2003). A resource explanation of this finding could assume that the WM resource is needed for maintaining the relevant goal (e.g., naming the print color), and when the resource runs low, the goal risks losing the competition against a conflicting habit (e.g., reading the color word). This explanation implies the prediction that WM capacity correlates with performance on attentional tasks involving a conflict between the relevant goal and a strong competing goal or habit, because these paradigms require strong goal maintenance to prevent goal

neglect. The Stroop task is an instance of an attentional paradigm with high goal conflict. Another paradigm inducing goal conflict is the antisaccade paradigm (Figure 14 A). In this paradigm, a visual cue is flashed on one side of the screen, and participants must make a saccade (i.e., an eye movement) to a target appearing on the other side, thereby overcoming the habit of moving the eyes toward a sudden-onset stimulus.

In contrast, WM capacity should be predicted to correlate less with attentional paradigms in which goal maintenance is less important. For instance, in the flanker paradigm (Figure 14 C) participants make speeded responses to a centrally presented stimulus flanked by distractor stimuli that can be incongruent with the target stimulus (i.e., they are linked to another response than the target), and therefore, must be ignored. A high attention-control score in the flanker task (i.e., a small cost of incongruent compared to congruent or neutral flankers) does not require minimizing the influence of a competing goal or habit, but minimizing the influence of distracting stimuli. The same can be said for visual search paradigms, in which efficient search requires attentional filtering of the distractors.

The task-switch paradigm (Figure 14D; Rogers & Monsell, 1995) also entails strong goal conflict because when participants switch back and forth between two tasks, the currently irrelevant task still has a strong tendency to intrude in response selection. Strong goal maintenance is therefore needed to carry out the currently relevant task and avoid distraction from the irrelevant task. However, strong goal maintenance does not help, and perhaps even stands in the way of, rapid, seamless switching between two tasks. Therefore, individuals with good goal maintenance would not be expected to have smaller task-switch costs than individuals with poor goal maintenance (Herd et al., 2014). Rather, individuals with good goal maintenance could be predicted to have smaller task-congruency costs, that is, smaller performance costs on trials with conflict between the currently relevant and the currently irrelevant task.

To summarize, a resource account linking WM capacity to goal maintenance predicts that WM capacity is correlated with successful attentional control on paradigms with high goal conflict, such as the Stroop task and the antisaccade task, but not on paradigms with low goal conflict, such as the flanker task and visual search. For the task-switch paradigm this account entails the prediction that WM capacity is correlated with the congruency effect, but not with the task-switch cost.

Extant findings provide support for this set of predictions: Indicators of attention from goal-conflict paradigms have been found to correlate with WM capacity (e.g., the Stroop effect, Kane & Engle, 2003; performance in the antisaccade task, Unsworth, Schrock, & Engle, 2004). In contrast, indicators of attention from paradigms without goal conflict have often been found to have only negligible correlations with WM capacity (e.g., the flanker task; Keye et al., 2009; Wilhelm et al., 2013; and most paradigms of visual search; Kane, Poole, Tuholski, & Engle, 2006; Sobel, Gerrie, Poole, & Kane, 2007). Task switch costs are virtually uncorrelated with WM capacity (Oberauer, Süß, Wilhelm, & Sander, 2007). The congruency effect in the task switching paradigm has, unfortunately, so far received little attention in individual-differences research (for a recent exception see Stahl et al., 2014), so the prediction that it correlates with WM capacity remains untested. We conclude that the resource hypothesis, com-

bined with the assumption that the WM resource is required for goal maintenance, provides a successful explanation of the pattern of correlations of WM capacity with indicators of attentional control.

Finally, if the resource limiting WM capacity is conceptualized as an attentional resource, it must be expected to also limit the capacity for simultaneously attending to multiple objects in the environment. Such a resource account predicts that measures of WM capacity correlate with performance on monitoring tasks and other tasks for measuring relational integration that involve no retention interval (C5).

Conclusion. The resource hypothesis—with the assumption of domain-general and domain-specific resources—predicts the factorial structure of WM capacity. It also provides an explanation for the correlation of WM capacity with processing speed and episodic memory. The resource account, combined with the assumption that goal maintenance requires the WM resource, can offer a detailed and largely accurate account of the pattern of correlations of WM capacity with measures reflecting aspects of attentional control. Finally, the resource hypothesis also correctly predicts that a measure of WM capacity does not necessarily involve a memory demand.

Interference

An interference account of WM capacity does not point to an obvious source of individual differences that generalizes across a broad range of paradigms and content domains. There are a number of parameters in interference models that could vary across individuals and explain individual and developmental differences in WM capacity and their factorial structure (C1), and recent work has explored some of these possibilities.

Factorial structure of WM (C1). One general source of individual differences could be the ability to control the contents of WM by preventing access of irrelevant material (“filtering”) and by removing WM contents that are no longer relevant (Oberauer, Lewandowsky, et al., 2012). Evidence for a role of filtering and removal in explaining individual differences in WM capacity is mixed at best. Some findings suggest that individual differences and age differences in WM capacity are related to the efficiency of filtering out irrelevant stimuli (Jost, Bryck, Vogel, & Mayr, 2011; Vogel, McCollough, & Machizawa, 2005), whereas others speak against such an association (Cowan, Morey, AuBuchon, Zwilling, & Gilchrist, 2010; Mall, Morey, Wolff, & Lehnert, 2014). There is preliminary evidence that the ability to remove information from WM declines with adult age (Cansino, Guzzon, Martinelli, Barollo, & Casco, 2011). However, one individual-differences study with a memory-updating paradigm found no correlation between measures of WM capacity and the efficiency of removal of outdated information from WM (Ecker, Lewandowsky, et al., 2014).

The distinctiveness of representations in long-term memory could be a source of domain-specific individual differences. Distinctive long-term memory representations play an important role for retrieval from WM. There is broad agreement among WM researchers that retrieval of an item from WM often returns a distorted representation of the original item, which needs to be disambiguated through a process often referred to as *redintegration* (Hulme, Roodenrys, Brown, & Mercer, 1995; Lewandowsky,

1999; Schweickert, 1993). Redintegration relies on comparing the distorted representation of an item retrieved from WM to long-term memory representations of known items in the set of recall candidates. Theories differ in what causes the distortion of memory traces—in interference models, distortion arises from interference by superposition. Individuals with more distinctive long-term knowledge can be expected to redintegrate more successfully. The distinctiveness of long-term knowledge arguably reflects at least in part the person's level of expertise in a content domain, so that distinctiveness might vary independently in different domains. Therefore, individual differences in distinctiveness of long-term memory representations could explain the domain-specific source of variance in WM capacity.

A simulation study with the SOB-CS model implemented individual differences in the removal of irrelevant information as a domain-general source of variation, together with differences in memory distinctiveness as a domain-specific source (Oberauer, Lewandowsky, et al., 2012). With these assumptions, the model was able to reproduce the factorial structure of simple and complex span tasks (C1; Kane et al., 2004).

Correlations with processing speed (C2). The interference hypothesis does not lend itself to a straightforward explanation of why WM capacity is correlated with processing speed. One possibility is that interference between representations in procedural WM influence processing speed (Oberauer, 2009). Procedural WM holds the current task set—the relevant stimulus and response categories and the mappings between them. The distinctiveness of stimulus and response representations, and the robustness of bindings between them, can be expected to determine the efficiency of response selection, which translates into the drift rate of the diffusion model (Schmiedek et al., 2007). This could explain why WM capacity is correlated specifically with the drift rate (C2). As an explanation along these lines has not been worked out yet, a conservative assessment is that the interference hypothesis is consistent with finding C2, but it does not yet offer an explanation for it.

Correlations with long-term memory (C3). Differences between people in their susceptibility to interference could also arise from differences in the distinctiveness of *context* representations (see Figure 1). For instance, individuals with more distinct context representations, such as list positions, are expected to perform better in remembering lists in order, because they are less likely to confuse items from different positions, and suffer less interference from superposition of item-context bindings. Differences in contextual distinctiveness have been shown to contribute to age differences in serial recall at the beginning (McCormack, Brown, Vousden, & Henson, 2000) and at the end of the life span (Maylor, Vousden, & Brown, 1999). On a more global level, more distinctive contexts also serve to distinguish the current memory set from those of previous trials, reducing proactive interference—this assumption could explain why WM capacity is correlated with the susceptibility to proactive interference (Kane & Engle, 2000).

In one interference-based computational model of serial and free recall (Farrell, 2012), variability in the distinctiveness of context representations serves as a key source of individual differences of WM capacity. Simulations with this model provide a detailed account of differences in recall behavior between individuals with high and with low WM capacity. Because contextual distinctiveness is relevant for immediate memory of short lists (as used for

testing WM) as well as for immediate or delayed recall of longer lists (as used for testing long-term memory), variations in this parameter also contributed to the common variance of indicators of WM and of episodic long-term memory in the model. Hence, at least one instantiation of an interference model provides an explanation for the correlation between WM capacity and long-term memory (C3).

Correlations with measures of attention (C4, C5). How could an interference account explain the relation between WM capacity and resistance to distraction in attentional paradigms (C4)? So far no such explanation has been worked out, so we can only offer a speculative sketch. Performance in attention-control paradigms such as the Stroop, the flanker, or the antisaccade tasks relies on task sets implementing the instructions. Task sets are procedural representations in WM that link conditions (e.g., target stimuli) to actions (e.g., pressing a button). These representations are in principle vulnerable to interference in the same way as other (declarative) representations in WM. Interference can arise from competing task sets. For instance, in the antisaccade task the habitual task set for moving the eyes toward a flashing light in the environment could interfere with the instructed task set for moving the eyes in the opposite direction, away from the flashing cue. In the task-switch paradigm, proactive interference arises from the currently not relevant task set that has been carried out just seconds ago (Allport, Styles, & Hsieh, 1994). People with high WM capacity might be good at protecting the current task set from interference by competing procedural representations, such as recently used task sets or habits (i.e., strong stimulus–response associations in long-term memory) by either filtering them (i.e., preventing them from intruding into procedural WM) or by removing them from procedural WM (Oberauer, Souza, Druery, & Gade, 2013).

This set of assumptions is similar to the idea discussed above of a WM resource responsible for goal maintenance, and it engenders a similar set of predictions: Individuals who are good at establishing robust task sets in procedural WM and protecting them against interference should be more successful in overcoming conflict from representations of competing stimulus-response mappings. Therefore, high WM capacity should be correlated with lower Stroop interference and better performance in the antisaccade task. High-capacity individuals should also be better at avoiding mind wandering (McVay & Kane, 2009) by filtering or removing task-irrelevant representations from (declarative and procedural) WM.

In the task-switch paradigm individuals with high WM capacity should show smaller costs of task incongruency. The predictions for task-switch costs depend on how WM capacity is assumed to be related to the two processes of controlling the contents of WM, filtering and removal. The ability to protect the current task set against interference by preventing other representations from entering procedural WM (i.e., filtering) should, if anything, hinder the rapid reconfiguration of the task set when a switch to another task is required. In contrast, the ability to remove representations from WM when they are no longer needed should facilitate task switching. If people with high WM are good at both filtering and removal, the opposing effect of these processes on task-switch costs should result in at best a small correlation of task-switch costs with WM capacity.

In the flanker paradigm, conflict from the flankers arises through the same stimulus-response bindings that mediate the

correct response. Therefore, individuals who are able to establish strong stimulus-response bindings in procedural WM should be more efficient in translating both the target stimulus and the flankers into representations of the responses mapped to them—and when these responses are in conflict with each other, performance will suffer no less than for a person with a weaker task set. Therefore, the size of the flanker effect is not predicted to correlate with WM capacity. In visual-search tasks, no conflicting action tendency needs to be overcome, so there is no reason to predict a correlation of search efficiency with WM capacity.

To summarize, the interference hypothesis, when applied to attention-control paradigms along the lines sketched above, can explain the pattern of correlations of WM capacity with indicators from the attention-control tasks that we already reviewed in connection with goal maintenance in the Resource section: WM capacity is correlated with the success of overcoming conflict in the Stroop and the antisaccade task, and more generally with the ability to prevent intrusions from task-unrelated representations into WM. WM capacity is only negligibly correlated with the flanker effect, with task-switch costs, and the efficiency of visual search. Therefore, the interference hypothesis, together with the assumption that individual differences in WM capacity arise in part from differences in the effectiveness of filtering and removal, can explain the relations of WM capacity to indicators of attentional control (C4), although many details of that explanation need to be worked out.

Finally, on the interference hypothesis we should expect that individual differences in WM capacity affect performance on any task that requires access to multiple distinct representations at the same time, whether these are representations of past events (i.e., memory representations) or of stimuli in the environment. Therefore, the interference hypothesis provides a natural explanation for the fact that monitoring tasks—requiring simultaneous access to multiple elements to determine their relations—are as valid measures of WM capacity as tasks measuring STM (C5).

Conclusion. Taken together, interference accounts can explain what is known about the correlational structure of WM capacity indicators. This explanatory potential has been demonstrated by a simulation with SOB-CS reproducing the factorial structure of a broad range of memory span tests (Oberauer, Lewandowsky, et al., 2012). This explanatory success, however, does not arise from the interference hypothesis on its own, but in conjunction with additional assumptions about the sources of individual differences. Therefore, interference theories do not predict a specific factor structure, and the source of individual differences in interference models of WM is yet to be determined. Distinctiveness of representations, together with the effectiveness of processes that control the contents of WM, are likely to play a central role in an interference-based explanation of individual differences.

Round C: Summary

Table 4 presents the score sheet for round C. The decay hypothesis struggled to explain why WM capacity is correlated with measures of attention that are not prone to decay (C4, C5). The resource and the interference hypothesis both fared well, with a better score for the resource hypothesis because it predicts two findings, the factor structure of WM (C1) and the correlation of

WM capacity with monitoring of multiple visual stimuli (C5). The interference hypothesis, by contrast, predicts only the latter and it offers a more speculative explanation for the correlation of WM capacity with speed measures (C2) than the resource hypothesis.

Discussion

We have evaluated three hypotheses about why the capacity of WM is limited by matching predictions from each hypothesis against a set of relevant and diagnostic findings. The assumption that representations in WM are lost because of rapid decay has appeal because it is simple and matches our personal experience of rapid forgetting of new information (Jonides et al., 2008). Much of the evidence we have reviewed above, however, speaks against decay having a primary role in limiting WM capacity. For verbal memoranda the evidence is against decay playing a role in determining retention over the short term; for visual and spatial memoranda decay might play a role, but is unlikely to determine the capacity limit, because the rate of forgetting that could be attributed to decay is too slow to explain the severe capacity limit observed at RIs of just one or two seconds, or even in the absence of any RI (Oberauer et al., 2003; Tsubomi et al., 2013).

An explanation of WM capacity in terms of resources has considerable strengths but also serious limitations. The main strength of this approach is that it explains why memory for some WM content is often found to be impaired by the concurrent maintenance or processing of material that appears to have little in common with that content. There are two main limitations: The resource account cannot explain why memory is impaired more by simultaneous maintenance or processing of material from the same category than of materials from different categories within a domain, and resource models cannot offer a coherent explanation for how distractor processing impairs memory. In particular, a resource account cannot explain why a longer duration of distractor processing impairs memory if and only if the distractors differ from each other, and it cannot explain why decreasing cognitive load by adding free time in between distractors improves memory.

The interference hypothesis offers a viable account of most of the findings in Tables 2 to 4. However, we identified two limitations: First, interference does not offer a natural explanation for the observations of time-based forgetting over unfilled RIs when temporal distinctiveness is controlled. Second, interference provides no straightforward explanation for why maintenance of a memory set is impaired by simultaneous maintenance or processing of other materials that have no apparent feature-space overlap with the memory set. These challenges do not appear to be insurmountable—we rather see them as a call for more in-depth analysis of the representations actually recruited when maintaining or processing the materials in question. In conclusion, we argue that interference is a promising approach to explaining the capacity limit of WM, although more theoretical and empirical work needs to be done to fully realize its potential.

No Family Wise Knock-Out Blows

One difficulty in evaluating the three hypotheses is that each of them actually represents an entire family of possible explanations, consisting of a potentially innumerable set of variants. The decay hypothesis is invariably accompanied by the assumption of one or

several restoration mechanisms, and the predictions of any decay theory depend substantially on the details of how restoration is thought to work (for a glimpse at the multiplicity of possible approaches see Chapter 2 of Lewandowsky & Farrell, 2011). The resource hypothesis can be fleshed out in many different ways concerning the number and scope of resources and the performance-resource functions for translating resource quantities into expected performance. The interference hypothesis reflects a family of different mechanisms of interference and their combinations. Therefore, all three hypotheses are highly flexible in what they predict. We have tried to nevertheless pin down predictions that follow from the basic hypothesis in question irrespective of the details, but we cannot logically rule out that versions of each hypothesis can be created that escape the challenges we have noted.

One troublesome aspect of the flexibility of all three hypotheses is that they raise the temptation of circular explanations. In the context of decay theories, when forgetting over time is observed, researchers conclude that restoration processes were not possible, or insufficient to compensate decay, whereas when no forgetting over time is observed, it is concluded that some form of rehearsal or refreshing must have prevented decay. This reasoning is circular as long as there is no independent measure of rehearsal or refreshing, or of the opportunity for engaging in such a restoration process. An independent assay of articulatory rehearsal can be obtained by asking people to rehearse overtly (Tan & Ward, 2008). Attention-based refreshing is more difficult to measure, and to date there is no independent evidence that people engage in refreshing during WM tasks at all—rather, the occurrence of refreshing is inferred from the performance data it is meant to explain. Nevertheless, at least the opportunity for refreshing—if not the process of refreshing itself—can be assessed by measuring for how long a distractor task engages the attentional bottleneck and setting that time in relation to the time available for the distractor task (Oberauer & Lewandowsky, 2013).

Resource theories risk becoming circular when the existence of shared resources is inferred from the observation of mutual impairment of two concurrent tasks, whereas the existence of separate resources is inferred from the (relative) lack of dual-task costs. There is no obvious way of measuring the resource demand of a task or process independently of dual-task costs. This is why the resource concept by itself is virtually untestable, as has been noted long ago (Navon, 1984). A testable resource theory of WM needs to specify which resources exist, what each resource is needed for, what its performance-resource function is, and how multiple resources operate together (i.e., whether their contributions to a process are combined additively or interactively). Whereas single-resource theories meeting these requirements have been proposed (Anderson et al., 1996; Ma et al., 2014), there is no equally well-defined multiple-resource theory of WM to date.

Interference theories are at risk of circular explanations when researchers infer the degree of similarity or feature-space overlap between two kinds of representations from the observed degree of mutual impairment of tasks recruiting these representations. To escape circularity, interference theorists need to find ways to assess similarity and feature-space overlap independently of their consequences for memory performance. One way to achieve this is to use stimuli varying in very low-dimensional, well-defined feature spaces such as color, orientation, or spatial frequency (Ka-

hana, Zhou, Geller, & Sekuler, 2007). The similarity of high-dimensional stimuli such as letters or words can be assessed through similarity ratings or acoustic confusion measurements, which can be submitted to multidimensional scaling to model the feature space (Farrell, 2006; Lewandowsky & Farrell, 2008a). Another approach might be to assess the similarity of patterns of neural activity during maintenance of different kinds of WM contents (Kriegeskorte & Kievit, 2013; Kriegeskorte, Mur, & Bandettini, 2008). Cross-dimensional congruency effects such as the SNARC⁵ effect (Nuerk, Wood, & Willmes, 2005) could also be used to detect overlaps of feature spaces of stimuli from different domains, such as numbers and spatial locations (cf. Walsh, 2003).

Combined Explanations

So far we have focused our investigation on how well decay, resource limits, or interference can explain the WM capacity limit on their own. This enabled us to identify the strengths and weaknesses of each hypothesis in isolation, and provided an evaluation of the most parsimonious explanations of WM capacity. In light of the fact that all of these explanations face some challenges, we next ask whether combinations of two or all three of the above hypotheses could provide a more powerful explanation. Some theories of WM build on such combinations—models based on ACT-R, for instance, combine a resource limit with decay and interference by confusion (Lovett et al., 1999), and Cowan's embedded-process theory combines a central, domain-general resource limit, the focus of attention, with the ability to hold information in the activated part of long-term memory, where they are susceptible to interference and decay (Cowan, 2005).

We argue that any combination that includes a role for decay in limiting WM capacity faces difficulties in explaining three findings: First, there is no forgetting for verbal memory lists over delays—of 10 s and more—during which both articulatory rehearsal and attention-based refreshing are engaged by a concurrent processing demand (Oberauer & Lewandowsky, 2008, 2013). Second, the measured capacity for visual stimuli is the same immediately after encoding—before any decay could have happened—as it is after a 1 s delay (Tsubomi et al., 2013). Third, some of the most valid tasks for measuring WM capacity involve no retention interval (Chuderski, 2014; Oberauer et al., 2003). These findings leave little room for a contribution of decay to an explanation of the capacity limit.

In contrast, a combination of interference with a domain-general resource limit appears viable. We note that the limitations of resource accounts and interference accounts are complementary: The resource hypothesis is challenged by findings that are explained well by interference, most notably the effects of set heterogeneity on the degree to which maintenance is impaired by other memory contents or by concurrent processing, and the finding that the duration of distractor processing matters if and only if distractors vary over time. Conversely, the assumption of a general resource provides a natural account for the mutual disruption of representations in WM when there is no apparent feature-space

⁵ Spatial-Numerical Association of Response Codes: People respond faster with a right key press when making judgments on larger numbers, and faster with a left key press when judging smaller numbers.

overlap between them. A combination of a general resource with interference fits well with theoretical frameworks that explain performance on WM tasks as being supported by at least two mechanisms: A domain-general core system limited to hold one or a few chunks, referred to as primary memory (Unsworth & Engle, 2007) or the focus of attention (Cowan, 2005; McElree, 2006), supplemented by mechanisms for maintaining and retrieving information in long-term memory over short periods of time. Because retrieval from long-term memory is generally assumed to be limited by interference, it would be reasonable to assume that interference constrains the contribution of the supplementary mechanisms. In contrast, the core system might be a limited resource. In light of the fact that interference alone explains most of the findings indicative of the WM capacity limit, the scope of the core mechanism might be very limited. A thorough investigation of the mutual disruption of maintenance of verbal and visual-spatial memory sets led Cowan et al. (2014) to the conclusion that the domain-general core mechanism holds just one item. Therefore, the core component of the WM system might be a focus of attention holding, in most circumstances, a single item or chunk (McElree, 2006; Oberauer & Hein, 2012).

Outlook

Where to from here? In this final section we briefly sketch possible avenues for advancing our understanding of the capacity limit of WM through further empirical and theoretical work.

Empirical desiderata. Whereas most of the findings in Tables 2 to 4 are clear-cut phenomena with solid empirical support, our review identified three areas in need of further empirical consolidation. First, it has emerged that the set-size effect on accuracy is an effect not only of the number of elements or chunks, but also their complexity (A1), but our knowledge of the effects of complexity remains patchy. In our review we summarized several findings under the umbrella term of “complexity effects,” but it is far from clear that, for instance, the number of phonemes in a word, the number of words in a chunk, and the number of features of a visual object all reflect the same kind of complexity. Complexity is a complex term, encompassing a variety of ways in which characteristics of memoranda can be varied, and we have only just begun to chart this territory empirically.

Second, the role of time in forgetting of visual and spatial memoranda (B3) is in need of further clarification: Under which conditions does memory decline over an unfilled retention interval, or a filled retention interval? When such a decline is observed, is it because of decay or related to reduced temporal distinctiveness? The mixed evidence on these questions reflects the large variety of materials and procedures used for addressing them, and it will take a systematic effort to tease apart the variables that determine under which conditions temporal factors affect memory for visual and spatial information in WM.

A third phenomenon on which more research is desirable is the heterogeneity benefit within content domains (A5 and B6). Whereas the available evidence consistently shows heterogeneity benefits, a systematic exploration of its origins is missing. In light of our analysis, which revealed that these findings are highly diagnostic for adjudicating between the interference hypothesis and its competitors, filling this gap seems important. One open question, for instance, is whether the benefit of

heterogeneous memory sets is more than just an instance of the benefit of dissimilarity within a memory set (Conrad & Hull, 1964; Poirier, Saint-Aubin, Musselwhite, Mohanadas, & Mahammed, 2007).

Theoretical prospects. We identified two promising avenues for understanding the capacity limit of WM, a purely interference-based model, or a model combining interference with a limited resource. Here we highlight a few challenges that theorists will have to meet to develop these approaches further.

A first question for an interference theory of WM capacity is whether—and if so, how—interference in WM differs from interference in long-term memory. Interference limits our ability to remember events and facts over the long term, but long-term memory is not constrained by a severe capacity limit of the kind that characterizes WM. From the perspective of unitary memory models such as SIMPLE (G. D. A. Brown et al., 2007) or the temporal-context model (Howard & Kahana, 2002; Sederberg, Howard, & Kahana, 2008), there is no qualitative difference between WM and long-term memory: The contents of WM are simply those memory contents that are best accessible, given the currently available retrieval cues. From this perspective, the capacity limit of WM is merely a reflection of the general limit on our ability to retrieve information from memory. One proposal for demarcating a special role for WM within a unitary framework is that the contents of WM can be accessed directly from the currently active context, whereas retrieval from episodic long-term memory requires first retrieving their context, which then can be used as cue to retrieve the content associated to it (Farrell, 2012).

Whereas unitary models emphasize the continuity of WM with long-term memory, they tend to neglect the close link of WM to attention. As we have noted throughout this review, the limited capacity of WM applies not only to memory for recent events but also to apprehension of information in the present perceptual environment, for instance when monitoring the relations between multiple stimuli (Oberauer et al., 2003), or when reporting visual features of objects that have been masked only a few milliseconds before (Sewell et al., 2014; Tsubomi et al., 2013). One task for further developing interference models of WM is to apply them to interference between representations of multiple objects attended to simultaneously.

We also need to work out how interference affects the representation of task sets in procedural WM to understand why WM capacity is correlated with the efficiency of response selection in simple speeded choice tasks (Schmiedek et al., 2007), and with measures of controlled attention (Kane et al., 2007). This effort could build on modeling work that aims to understand WM and executive control within a unitary framework (Chatham et al., 2011; Herd et al., 2014; Oberauer et al., 2013). Extending the notion of interference to capacity limits on attention might lead to an understanding of the mechanisms of interference that departs substantially from that in models of memory.

One possible difference between interference in memory and interference in attention could be that memory relies on information coded in synaptic connection weights, whereas attention operates on information coded by ongoing neural activity. In unitary memory models information is maintained in connection weights. In contrast, stimuli currently attended to are coded by patterns of

neural activity, and this is also true for at least some stimuli held in WM (Emrich, Rigall, Larocque, & Postle, 2013)—although apparently only those currently attended to (Lewis-Peacock, Drysdale, Oberauer, & Postle, 2012). If representations of several items are simultaneously represented in WM through persistent neural firing patterns, do they interfere with each other, and can this interference be characterized by mechanisms analogous to those governing associative memory models?

The second promising approach for explaining WM capacity is a combination of interference with a resource limit. The challenge for this approach is to integrate these two hypotheses into a precise mechanistic model. One path toward an integration would be to start from an interference model and add a resource-limited central component to it that maintains one, or a small number, of representations (e.g., the free-recall model of Davelaar et al., 2005). Such a model will have to specify how the capacity-limited component cooperates with the interference-limited component in generating behavior on various paradigms for studying WM. Determining how the assumed mechanisms of two components operate together engenders a level of complexity that is best handled by computational modeling.

This challenge illustrates a general point (cf. Farrell & Lewandowsky, 2010; Hintzman, 1991): A computational implementation of one's assumptions about how the WM system works—as a set of equations or a simulation program—helps to uncover inconsistencies of assumptions and unanticipated behavior resulting from the interaction of several mechanisms. Most important, computational modeling enables researchers to unambiguously determine the predictions that follow from a hypothesis—for instance, about the cause of the WM capacity limit—in conjunction with a set of additional assumptions. To the extent that future theorizing about WM and its capacity limit is based on computational modeling, a future review will be better placed to systematically map out which findings are core predictions of which models, and what the shortcomings of particular models tell us about the processes that underlie benchmark phenomena.

Conclusion

To conclude, we argue that two theoretical approaches hold the best promise for an adequate explanation of the WM capacity limit. One is an explanation based only on interference. Researchers following this route should make it a priority to develop a detailed explanation of interference between very different contents in WM. The other approach is to combine the interference hypothesis with a domain-general core mechanism of very limited scope. Work along this line needs to flesh out in more detail how the resource limit is to be combined with the mechanisms of interference.

References

- Allen, R. J., Baddeley, A. D., & Hitch, G. J. (2006). Is the binding of visual features in working memory resource-demanding? *Journal of Experimental Psychology: General*, *135*, 298–313. <http://dx.doi.org/10.1037/0096-3445.135.2.298>
- Allport, A., Styles, E. A., & Hsieh, S. (1994). Shifting intentional set: Exploring the dynamic control of tasks. In C. Umiltà & M. Moscovitch (Eds.), *Attention & performance* (Vol. XV, pp. 421–452). Cambridge, MA: MIT Press.
- Altmann, E. M., & Gray, W. D. (2002). Forgetting to remember: The functional relationship of decay and interference. *Psychological Science*, *13*, 27–33. <http://dx.doi.org/10.1111/1467-9280.00405>
- Alvarez, G. A., & Cavanagh, P. (2004). The capacity of visual short-term memory is set both by visual information load and by number of objects. *Psychological Science*, *15*, 106–111. <http://dx.doi.org/10.1111/j.0963-7214.2004.01502006.x>
- Anderson, J. R., Reder, L. M., & Lebiere, C. (1996). Working memory: Activation limitations on retrieval. *Cognitive Psychology*, *30*, 221–256. <http://dx.doi.org/10.1006/cogp.1996.0007>
- Awh, E., Barton, B., & Vogel, E. K. (2007). Visual working memory represents a fixed number of items regardless of complexity. *Psychological Science*, *18*, 622–628. <http://dx.doi.org/10.1111/j.1467-9280.2007.01949.x>
- Awh, E., Jonides, J., & Reuter-Lorenz, P. A. (1998). Rehearsal in spatial working memory. *Journal of Experimental Psychology: Human Perception and Performance*, *24*, 780–790. <http://dx.doi.org/10.1037/0096-1523.24.3.780>
- Baddeley, A. D. (1966). Short-term memory for word sequences as a function of acoustic, semantic and formal similarity. *The Quarterly Journal of Experimental Psychology*, *18*, 362–365. <http://dx.doi.org/10.1080/14640746608400055>
- Baddeley, A. D. (1986). *Working memory*. Oxford: Clarendon Press.
- Baddeley, A. D. (2001). Is working memory still working? *American Psychologist*, *56*, 851–864. <http://dx.doi.org/10.1037/0003-066X.56.11.851>
- Baddeley, A. (2012). Working memory: Theories, models, and controversies. *Annual Review of Psychology*, *63*, 1–29. <http://dx.doi.org/10.1146/annurev-psych-120710-100422>
- Baddeley, A. D., & Hitch, G. J. (1974). Working memory. In G. H. Bower (Ed.), *Recent advances in learning and motivation* (Vol. VIII, pp. 47–90). New York, NY: Academic Press.
- Baddeley, A. D., Thomson, N., & Buchanan, M. (1975). Word length and the structure of short term memory. *Journal of Verbal Learning and Verbal Behavior*, *14*, 575–589. [http://dx.doi.org/10.1016/S0022-5371\(75\)80045-4](http://dx.doi.org/10.1016/S0022-5371(75)80045-4)
- Bancroft, T. D., Servos, P., & Hockley, W. E. (2011). Mechanisms of interference in vibrotactile working memory. *PLoS ONE*, *6*. <http://dx.doi.org/10.1371/journal.pone.0022518>
- Barrouillet, P., Bernardin, S., & Camos, V. (2004). Time constraints and resource sharing in adults' working memory spans. *Journal of Experimental Psychology: General*, *133*, 83–100. <http://dx.doi.org/10.1037/0096-3445.133.1.83>
- Barrouillet, P., Bernardin, S., Portrat, S., Vergauwe, E., & Camos, V. (2007). Time and cognitive load in working memory. *Journal of Experimental Psychology: Learning, Memory, and Cognition*, *33*, 570–585. <http://dx.doi.org/10.1037/0278-7393.33.3.570>
- Barrouillet, P., Portrat, S., Vergauwe, E., Diependaele, K., & Camos, V. (2011). Further evidence for temporal decay in working memory: Reply to Lewandowsky and Oberauer (2009). *Journal of Experimental Psychology: Learning, Memory, and Cognition*, *37*, 1302–1317. <http://dx.doi.org/10.1037/a0022933>
- Bayliss, D. M., Jarrold, C., Gunn, D. M., & Baddeley, A. D. (2003). The complexities of complex span: Explaining individual differences in working memory in children and adults. *Journal of Experimental Psychology: General*, *132*, 71–92. <http://dx.doi.org/10.1037/0096-3445.132.1.71>
- separable? *Child Development*, *77*, 1698–1716. <http://dx.doi.org/10.1111/j.1467-8624.2006.00968.x>

- Bays, P. M. (2014). Noise in neural populations accounts for errors in working memory. *The Journal of Neuroscience*, *34*, 3632–3645. <http://dx.doi.org/10.1523/JNEUROSCI.3204-13.2014>
- Belopol'sky, A. V., & Theeuwes, J. (2009). No functional role of attention-based rehearsal in maintenance of spatial working memory representations. *Acta Psychologica*, *132*, 124–135. <http://dx.doi.org/10.1016/j.actpsy.2009.01.002>
- Brady, T. F., & Alvarez, G. A. (2015). No evidence for a fixed object limit in working memory: Spatial ensemble representations inflate estimates of working memory capacity for complex objects. *Journal of Experimental Psychology: Learning, Memory, and Cognition*, *41*, 921–929. <http://dx.doi.org/10.1037/xlm0000075>
- Brown, G. D. A., Neath, I., & Chater, N. (2007). A temporal ratio model of memory. *Psychological Review*, *114*, 539–576. <http://dx.doi.org/10.1037/0033-295X.114.3.539>
- Brown, G. D. A., Preece, T., & Hulme, C. (2000). Oscillator-based memory for serial order. *Psychological Review*, *107*, 127–181. <http://dx.doi.org/10.1037/0033-295X.107.1.127>
- Brown, J. (1958). Some tests of the decay theory of immediate memory. *The Quarterly Journal of Experimental Psychology*, *10*, 12–21. <http://dx.doi.org/10.1080/17470215808416249>
- Buehner, M., Krumm, S., & Pick, M. (2005). Reasoning = working memory ≠ attention. *Intelligence*, *33*, 251–272. <http://dx.doi.org/10.1016/j.intell.2005.01.002>
- Buehner, M., Krumm, S., Ziegler, M., & Pluecken, T. (2006). Cognitive abilities and their interplay. Reasoning, crystallized intelligence, working memory components, and sustained attention. *Journal of Individual Differences*, *27*, 57–72. <http://dx.doi.org/10.1027/1614-0001.27.2.57>
- Burgess, N., & Hitch, G. J. (1999). Memory for serial order: A network model of the phonological loop and its timing. *Psychological Review*, *106*, 551–581. <http://dx.doi.org/10.1037/0033-295X.106.3.551>
- Burgess, N., & Hitch, G. J. (2006). A revised model of short-term memory and long-term learning of verbal sequences. *Journal of Memory and Language*, *55*, 627–652. <http://dx.doi.org/10.1016/j.jml.2006.08.005>
- Camos, V., Lagner, P., & Barrouillet, P. (2009). Two maintenance mechanisms of verbal information in working memory. *Journal of Memory and Language*, *61*, 457–469. <http://dx.doi.org/10.1016/j.jml.2009.06.002>
- Camos, V., & Portrat, S. (2015). The impact of cognitive load on delayed recall. *Psychonomic Bulletin & Review*, *22*, 1029–1034. <http://dx.doi.org/10.3758/s13423-014-0772-5>
- Cansino, S., Guzzon, D., Martinelli, M., Barollo, M., & Casco, C. (2011). Effects of aging on interference control in selective attention and working memory. *Memory & Cognition*, *39*, 1409–1422. <http://dx.doi.org/10.3758/s13421-011-0109-9>
- Carrier, L. M., & Pashler, H. (1995). Attentional limits in memory retrieval. *Journal of Experimental Psychology: Learning, Memory, and Cognition*, *21*, 1339–1348. <http://dx.doi.org/10.1037/0278-7393.21.5.1339>
- Case, R., Kurland, M., & Goldberg, J. (1982). Operational efficiency and the growth of short-term memory span. *Journal of Experimental Child Psychology*, *33*, 386–404. [http://dx.doi.org/10.1016/0022-0965\(82\)90054-6](http://dx.doi.org/10.1016/0022-0965(82)90054-6)
- Chatham, C. H., Herd, S. A., Brant, A. M., Hazy, T. E., Miyake, A., O'Reilly, R., & Friedman, N. P. (2011). From an executive network to executive control: A computational model of the n-back task. *Journal of Cognitive Neuroscience*, *23*, 3598–3619. http://dx.doi.org/10.1162/jocn_a_00047
- Chechile, R. A. (1987). Trace susceptibility theory. *Journal of Experimental Psychology: General*, *116*, 203–222. <http://dx.doi.org/10.1037/0096-3445.116.3.203>
- Chein, J. M., Moore, A. B., & Conway, A. R. A. (2011). Domain-general mechanisms of complex working memory span. *NeuroImage*, *54*, 550–559. <http://dx.doi.org/10.1016/j.neuroimage.2010.07.067>
- Chen, Z., & Cowan, N. (2005). Chunk limits and length limits in immediate recall: A reconciliation. *Journal of Experimental Psychology: Learning, Memory, and Cognition*, *31*, 1235–1249. <http://dx.doi.org/10.1037/0278-7393.31.6.1235>
- Chen, Z., & Cowan, N. (2009). Core verbal working-memory capacity: The limit in words retained without covert articulation. *The Quarterly Journal of Experimental Psychology: Human Experimental Psychology*, *62*, 1420–1429. <http://dx.doi.org/10.1080/17470210802453977>
- Christie, D. F. M., & Phillips, W. A. (1979). Simple drawing and pattern completion techniques for studying visualization and long-term visual knowledge. *Memory & Cognition*, *7*, 360–367. <http://dx.doi.org/10.3758/BF03196940>
- Chuderski, A. (2014). The relational integration task explains fluid reasoning above and beyond other working memory tasks. *Memory & Cognition*, *42*, 448–463. <http://dx.doi.org/10.3758/s13421-013-0366-x>
- Chuderski, A., Taraday, M., Nećka, E., & Smoleń, T. (2012). Storage capacity explains fluid intelligence but executive control does not. *Intelligence*, *40*, 278–295. <http://dx.doi.org/10.1016/j.intell.2012.02.010>
- Cocchini, G., Logie, R. H., Della Sala, S., MacPherson, S. E., & Baddeley, A. D. (2002). Concurrent performance of two memory tasks: Evidence for domain-specific working memory systems. *Memory & Cognition*, *30*, 1086–1095. <http://dx.doi.org/10.3758/BF03194326>
- Conlin, J. A., & Gathercole, S. E. (2006). Lexicality and interference in working memory in children and in adults. *Journal of Memory and Language*, *55*, 363–380. <http://dx.doi.org/10.1016/j.jml.2006.05.003>
- Conlin, J. A., Gathercole, S. E., & Adams, J. W. (2005). Stimulus similarity decrements in children's working memory span. *The Quarterly Journal of Experimental Psychology*, *58*, 1434–1446. <http://dx.doi.org/10.1080/02724980443000683>
- Conrad, R. (1964). Acoustic confusions in immediate memory. *British Journal of Psychology*, *55*, 75–84. <http://dx.doi.org/10.1111/j.2044-8295.1964.tb00899.x>
- Conrad, R., & Hull, A. J. (1964). Information, acoustic confusion and memory span. *British Journal of Psychology*, *55*, 429–432. <http://dx.doi.org/10.1111/j.2044-8295.1964.tb00928.x>
- Conrad, R., & Hull, A. J. (1966). The role of the interpolated task in short-term retention. *The Quarterly Journal of Experimental Psychology*, *18*, 266–269. <http://dx.doi.org/10.1080/14640746608400039>
- Conway, A. R. A., Jarrold, C., Kane, M. J., Miyake, A., & Towse, J. N. (Eds.). (2007). *Variation in working memory*. New York, NY: Oxford University Press.
- Conway, A. R. A., Kane, M. J., & Engle, R. W. (2003). Working memory capacity and its relation to general intelligence. *Trends in Cognitive Sciences*, *7*, 547–552. <http://dx.doi.org/10.1016/j.tics.2003.10.005>
- Cowan, N. (2001). The magical number 4 in short-term memory: A reconsideration of mental storage capacity. *Behavioral and Brain Sciences*, *24*, 87–114. <http://dx.doi.org/10.1017/S0140525X01003922>
- Cowan, N. (2005). *Working memory capacity*. New York, NY: Psychology Press. <http://dx.doi.org/10.4324/9780203342398>
- Cowan, N., Blume, C. L., & Saults, J. S. (2013). Attention to attributes and objects in working memory. *Journal of Experimental Psychology: Learning, Memory, and Cognition*, *39*, 731–747. <http://dx.doi.org/10.1037/a0029687>
- Cowan, N., Day, L., Saults, J. S., Keller, T. A., Johnson, T. D., & Flores, L. (1992). The role of verbal output time in the effects of word length on immediate memory. *Journal of Memory and Language*, *31*, 1–17. [http://dx.doi.org/10.1016/0749-596X\(92\)90002-F](http://dx.doi.org/10.1016/0749-596X(92)90002-F)
- Cowan, N., Elliott, E. M., Saults, J. S., Nugent, L. D., Bomb, P., & Hismjatullina, A. (2006). Rethinking speed theories of cognitive development. Increasing the rate of recall without affecting accuracy. *Psychological Science*, *17*, 67–73. <http://dx.doi.org/10.1111/j.1467-9280.2005.01666.x>
- Cowan, N., Morey, C. C., AuBuchon, A. M., Zwilling, C. E., & Gilchrist, A. L. (2010). Seven-year-olds allocate attention like adults unless work-

- ing memory is overloaded. *Developmental Science*, 13, 120–133. <http://dx.doi.org/10.1111/j.1467-7687.2009.00864.x>
- Cowan, N., Rouder, J. N., Blume, C. L., & Saults, J. S. (2012). Models of verbal working memory capacity: What does it take to make them work? *Psychological Review*, 119, 480–499. <http://dx.doi.org/10.1037/a0027791>
- Cowan, N., Saults, J. S., & Blume, C. L. (2014). Central and peripheral components of working memory storage. *Journal of Experimental Psychology: General*, 143, 1806–1836. <http://dx.doi.org/10.1037/a0036814>
- Cowan, N., Wood, N. L., Wood, P. K., Keller, T. A., Nugent, L. D., & Keller, C. V. (1998). Two separate verbal processing rates contributing to short-term memory span. *Journal of Experimental Psychology: General*, 127, 141–160. <http://dx.doi.org/10.1037/0096-3445.127.2.141>
- Dambacher, M., & Hübner, R. (2015). Time pressure affects the efficiency of perceptual processing in decisions under conflict. *Psychological Research*, 79, 83–94.
- Daneman, M., & Carpenter, P. A. (1980). Individual differences in working memory and reading. *Journal of Verbal Learning and Verbal Behavior*, 19, 450–466. [http://dx.doi.org/10.1016/S0022-5371\(80\)90312-6](http://dx.doi.org/10.1016/S0022-5371(80)90312-6)
- Darley, C. F., & Glass, A. L. (1975). Effects of rehearsal and serial list position on recall. *Journal of Experimental Psychology: Human Learning and Memory*, 1, 453–458. <http://dx.doi.org/10.1037/0278-7393.1.4.453>
- Davelaar, E. J., Goshen-Gottstein, Y., Ashkenazi, A., Haarmann, H. J., & Usher, M. (2005). The demise of short-term memory revisited: Empirical and computational investigations of recency effects. *Psychological Review*, 112, 3–42. <http://dx.doi.org/10.1037/0033-295X.112.1.3>
- Davis, L. C., Rane, S., & Hiscock, M. (2013). Serial recall of visuospatial and verbal information with and without material-specific interference: Implications for contemporary models of working memory. *Memory*, 21, 778–797. <http://dx.doi.org/10.1080/09658211.2012.756037>
- Delvenne, J.-B., & Bruyer, R. (2004). Does visual short-term memory store bound features? *Visual Cognition*, 11, 1–27. <http://dx.doi.org/10.1080/13506280344000167>
- Depoorter, A., & Vandierendonck, A. (2009). Evidence for modality-independent order coding in working memory. *The Quarterly Journal of Experimental Psychology: Human Experimental Psychology*, 62, 531–549. <http://dx.doi.org/10.1080/17470210801995002>
- Dosher, B. A., & Ma, J. J. (1998). Output loss or rehearsal loop? Output-time versus pronunciation-time limits in immediate recall for forgetting-matched materials. *Journal of Experimental Psychology: Learning, Memory, and Cognition*, 24, 316–335. <http://dx.doi.org/10.1037/0278-7393.24.2.316>
- Dubé, C., Zhou, F., Kahana, M. J., & Sekuler, R. (2014). Similarity-based distortion of visual short-term memory is due to perceptual averaging. *Vision Research*, 96, 8–16. <http://dx.doi.org/10.1016/j.visres.2013.12.016>
- Ecker, U. K. H., Lewandowsky, S., & Oberauer, K. (2014). Removal of information from working memory: A specific updating process. *Journal of Memory and Language*, 74, 77–90. <http://dx.doi.org/10.1016/j.jml.2013.09.003>
- Ecker, U. K. H., Oberauer, K., & Lewandowsky, S. (2014). Working memory updating involves item-specific removal. *Journal of Memory and Language*, 74, 1–15.
- Emrich, S. M., Riggall, A. C., Larocque, J. J., & Postle, B. R. (2013). Distributed patterns of activity in sensory cortex reflect the precision of multiple items maintained in visual short-term memory. *The Journal of Neuroscience*, 33, 6516–6523. <http://dx.doi.org/10.1523/JNEUROSCI.5732-12.2013>
- Farrell, S. (2006). Mixed-list phonological similarity effects in delayed serial recall. *Journal of Memory and Language*, 55, 587–600. <http://dx.doi.org/10.1016/j.jml.2006.06.002>
- Farrell, S. (2012). Temporal clustering and sequencing in short-term memory and episodic memory. *Psychological Review*, 119, 223–271. <http://dx.doi.org/10.1037/a0027371>
- Farrell, S., & Lewandowsky, S. (2002). An endogenous distributed model of ordering in serial recall. *Psychonomic Bulletin & Review*, 9, 59–79. <http://dx.doi.org/10.3758/BF03196257>
- Farrell, S., & Lewandowsky, S. (2010). Computational models as aids to better reasoning in psychology. *Current Directions in Psychological Science*, 19, 329–335. <http://dx.doi.org/10.1177/0963721410386677>
- Farrell, S., & Lewandowsky, S. (2012). Response suppression contributes to recency in serial recall. *Memory & Cognition*, 40, 1070–1080. <http://dx.doi.org/10.3758/s13421-012-0212-6>
- Farrell, S., & Oberauer, K. (2014). Working memory for cross-domain sequences. *The Quarterly Journal of Experimental Psychology*, 67, 33–44. <http://dx.doi.org/10.1080/17470218.2013.795177>
- Ferguson, A. N., & Bowey, J. A. (2005). Global processing speed as a mediator of developmental changes in children's auditory memory span. *Journal of Experimental Child Psychology*, 91, 89–112. <http://dx.doi.org/10.1016/j.jecp.2004.12.006>
- Fougnie, D., & Marois, R. (2011). What limits working memory capacity? Evidence for modality-specific sources to the simultaneous storage of visual and auditory arrays. *Journal of Experimental Psychology: Learning, Memory, and Cognition*, 37, 1329–1341. <http://dx.doi.org/10.1037/a0024834>
- Fougnie, D., Zughni, S., Godwin, D., & Marois, R. (2015). Working memory storage is intrinsically domain specific. *Journal of Experimental Psychology: General*, 144, 30–47. <http://dx.doi.org/10.1037/a0038211>
- Fukuda, K., Awh, E., & Vogel, E. K. (2010). Discrete capacity limits in visual working memory. *Current Opinion in Neurobiology*, 20, 177–182. <http://dx.doi.org/10.1016/j.conb.2010.03.005>
- Gaillard, V., Barrouillet, P., Jarrold, C., & Camos, V. (2011). Developmental differences in working memory: Where do they come from? *Journal of Experimental Child Psychology*, 110, 469–479. <http://dx.doi.org/10.1016/j.jecp.2011.05.004>
- Gavens, N., & Barrouillet, P. (2004). Delays of retention, processing efficiency, and attentional resources in working memory span development. *Journal of Memory and Language*, 51, 644–657. <http://dx.doi.org/10.1016/j.jml.2004.06.009>
- Gold, J. M., Murray, R. F., Sekuler, A. B., Bennett, P. J., & Sekuler, R. (2005). Visual memory decay is deterministic. *Psychological Science*, 16, 769–774. <http://dx.doi.org/10.1111/j.1467-9280.2005.01612.x>
- Gorgoraptis, N., Catalao, R. F. G., Bays, P. M., & Husain, M. (2011). Dynamic updating of working memory resources for visual objects. *The Journal of Neuroscience*, 31, 8502–8511. <http://dx.doi.org/10.1523/JNEUROSCI.0208-11.2011>
- Greene, R. L. (1987). Effects of maintenance rehearsal on human memory. *Psychological Bulletin*, 102, 403–413. <http://dx.doi.org/10.1037/0033-2909.102.3.403>
- Hale, S., Myerson, J., Rhee, S. H., Weiss, C. S., & Abrams, R. A. (1996). Selective interference with the maintenance of location information in visual working memory. *Neuropsychology*, 10, 228–240. <http://dx.doi.org/10.1037/0894-4105.10.2.228>
- Halford, G. S., Cowan, N., & Andrews, G. (2007). Separating cognitive capacity from knowledge: A new hypothesis. *Trends in Cognitive Sciences*, 11, 236–242. <http://dx.doi.org/10.1016/j.tics.2007.04.001>
- Hardman, K. O., & Cowan, N. (2015). Remembering complex objects in visual working memory: Do capacity limits restrict objects or features? *Journal of Experimental Psychology: Learning, Memory, and Cognition*, 41, 325–347. <http://dx.doi.org/10.1037/xlm0000031>
- Heitz, R. P., & Engle, R. W. (2007). Focusing the spotlight: Individual differences in visual attention control. *Journal of Experimental Psychology: General*, 136, 217–240. <http://dx.doi.org/10.1037/0096-3445.136.2.217>

- Herd, S. A., O'Reilly, R. C., Hazy, T. E., Chatham, C. H., Brant, A. M., & Friedman, N. P. (2014). A neural network model of individual differences in task switching abilities. *Neuropsychologia*, *62*, 375–389. <http://dx.doi.org/10.1016/j.neuropsychologia.2014.04.014>
- Hintzman, D. L. (1991). Why are formal models useful in psychology? In W. E. Hockley & S. Lewandowsky (Eds.), *Relating theory and data: Essays on human memory in honor of Bennet B. Murdock* (pp. 39–56). Hillsdale, NJ: Erlbaum.
- Hole, G. J. (1996). Decay and interference effects in visuospatial short-term memory. *Perception*, *25*, 53–64. <http://dx.doi.org/10.1068/p250053>
- Horoufchin, H., Philipp, A. M., & Koch, I. (2011). The dissipating task-repetition benefit in cued task switching: Task-set decay or temporal distinctiveness? *Journal of Experimental Psychology: Human Perception and Performance*, *37*, 455–472. <http://dx.doi.org/10.1037/a0020557>
- Howard, M. W., & Kahana, M. J. (2002). A distributed representation of temporal context. *Journal of Mathematical Psychology*, *46*, 269–299. <http://dx.doi.org/10.1006/jmps.2001.1388>
- Huang, J., & Sekuler, R. (2010). Distortions in recall from visual memory: Two classes of attractors at work. *Journal of Vision*, *10*, 1–27. <http://dx.doi.org/10.1167/10.2.24>
- Hulme, C., Roodenrys, S., Brown, G., & Mercer, R. (1995). The role of long-term memory mechanisms in memory span. *British Journal of Psychology*, *86*, 527–536. <http://dx.doi.org/10.1111/j.2044-8295.1995.tb02570.x>
- Humphreys, M. S., Maguire, A. M., McFarlane, K. A., Burt, J. S., Bolland, S. W., Murray, K. L., & Dunn, R. (2010). Using maintenance rehearsal to explore recognition memory. *Journal of Experimental Psychology: Learning, Memory, and Cognition*, *36*, 147–159. <http://dx.doi.org/10.1037/a0017687>
- Hurlstone, M. J., Hitch, G. J., & Baddeley, A. D. (2014). Memory for serial order across domains: An overview of the literature and directions for future research. *Psychological Bulletin*, *140*, 339–373.
- Jalbert, A., Neath, I., Bireta, T. J., & Surprenant, A. M. (2011). When does length cause the word length effect? *Journal of Experimental Psychology: Learning, Memory, and Cognition*, *37*, 338–353. <http://dx.doi.org/10.1037/a0021804>
- Jalbert, A., Neath, I., & Surprenant, A. M. (2011). Does length or neighborhood size cause the word length effect? *Memory & Cognition*, *39*, 1198–1210. <http://dx.doi.org/10.3758/s13421-011-0094-z>
- Jarrold, C., Tam, H., Baddeley, A. D., & Harvey, C. E. (2010). The nature and position of processing determines why forgetting occurs in working memory tasks. *Psychonomic Bulletin & Review*, *17*, 772–777. <http://dx.doi.org/10.3758/PBR.17.6.772>
- Jarrold, C., Tam, H., Baddeley, A. D., & Harvey, C. E. (2011). How does processing affect storage in working memory tasks? Evidence for both domain-general and domain-specific effects. *Journal of Experimental Psychology: Learning, Memory, and Cognition*, *37*, 688–705. <http://dx.doi.org/10.1037/a0022527>
- Jarrold, C., & Towse, J. N. (2006). Individual differences in working memory. *Neuroscience*, *139*, 39–50. <http://dx.doi.org/10.1016/j.neuroscience.2005.07.002>
- Jensen, A. R. (1988). Speed of information processing and population differences. In S. H. Irvine & J. W. Berry (Eds.), *Human abilities in cultural context* (pp. 105–145). Cambridge, United Kingdom: Cambridge University Press.
- Joliceur, P., & Dell'Acqua, R. (1998). The demonstration of short-term consolidation. *Cognitive Psychology*, *36*, 138–202. <http://dx.doi.org/10.1006/cogp.1998.0684>
- Jones, D., Farrand, P., Stuart, G., & Morris, N. (1995). Functional equivalence of verbal and spatial information in serial short-term memory. *Journal of Experimental Psychology: Learning, Memory, and Cognition*, *21*, 1008–1018. <http://dx.doi.org/10.1037/0278-7393.21.4.1008>
- Jones, D. M., & Macken, W. J. (1993). Irrelevant tones produce an irrelevant speech effect: Implications for phonological coding in working memory. *Journal of Experimental Psychology: Learning, Memory, and Cognition*, *19*, 369–381. <http://dx.doi.org/10.1037/0278-7393.19.2.369>
- Jonides, J., Lewis, R. L., Nee, D. E., Lustig, C. A., Berman, M. G., & Moore, K. S. (2008). The mind and brain of short-term memory. *Annual Review of Psychology*, *59*, 193–224. <http://dx.doi.org/10.1146/annurev.psych.59.103006.093615>
- Jost, K., Bryck, R. L., Vogel, E. K., & Mayr, U. (2011). Are old adults just like low working memory young adults? Filtering efficiency and age differences in visual working memory. *Cerebral Cortex*, *21*, 1147–1154. <http://dx.doi.org/10.1093/cercor/bhq185>
- Jünger, E., Kliegl, R., & Oberauer, K. (2014). No evidence for feature overwriting in visual working memory. *Memory*, *22*, 374–389. <http://dx.doi.org/10.1080/09658211.2013.794243>
- Just, M. A., & Carpenter, P. A. (1992). A capacity theory of comprehension: Individual differences in working memory. *Psychological Review*, *99*, 122–149. <http://dx.doi.org/10.1037/0033-295X.99.1.122>
- Kahana, M. J., & Sekuler, R. (2002). Recognizing spatial patterns: A noisy exemplar approach. *Vision Research*, *42*, 2177–2192. [http://dx.doi.org/10.1016/S0042-6989\(02\)00118-9](http://dx.doi.org/10.1016/S0042-6989(02)00118-9)
- Kahana, M. J., Zhou, F., Geller, A. S., & Sekuler, R. (2007). Lure similarity affects visual episodic recognition: Detailed tests of a noisy exemplar model. *Memory & Cognition*, *35*, 1222–1232. <http://dx.doi.org/10.3758/BF03193596>
- Kail, R. (1992). Processing speed, speech rate, and memory. *Developmental Psychology*, *28*, 899–904. <http://dx.doi.org/10.1037/0012-1649.28.5.899>
- Kail, R. (1997). Phonological skill and articulation time independently contribute to the development of memory span. *Journal of Experimental Child Psychology*, *67*, 57–68. <http://dx.doi.org/10.1006/jecp.1997.2393>
- Kane, M. J., Conway, A. R. A., Hambrick, D. Z., & Engle, R. W. (2007). Variation in working memory capacity as variation in executive attention and control. In A. R. A. Conway, C. Jarrold, M. J. Kane, A. Miyake, & J. N. Towse (Eds.), *Variation in working memory* (pp. 21–48). New York, NY: Oxford University Press.
- Kane, M. J., & Engle, R. W. (2000). Working-memory capacity, proactive interference, and divided attention: Limits on long-term memory retrieval. *Journal of Experimental Psychology: Learning, Memory, and Cognition*, *26*, 336–358. <http://dx.doi.org/10.1037/0278-7393.26.2.336>
- Kane, M. J., & Engle, R. W. (2003). Working-memory capacity and the control of attention: The contributions of goal neglect, response competition, and task set to Stroop interference. *Journal of Experimental Psychology: General*, *132*, 47–70. <http://dx.doi.org/10.1037/0096-3445.132.1.47>
- Kane, M. J., Hambrick, D. Z., Tuholski, S. W., Wilhelm, O., Payne, T. W., & Engle, R. W. (2004). The generality of working memory capacity: A latent-variable approach to verbal and visuospatial memory span and reasoning. *Journal of Experimental Psychology: General*, *133*, 189–217. <http://dx.doi.org/10.1037/0096-3445.133.2.189>
- Kane, M. J., Poole, B. J., Tuholski, S. W., & Engle, R. W. (2006). Working memory capacity and the top-down control of visual search: Exploring the boundaries of “executive attention”. *Journal of Experimental Psychology: Learning, Memory, and Cognition*, *32*, 749–777. <http://dx.doi.org/10.1037/0278-7393.32.4.749>
- Keye, D., Wilhelm, O., Oberauer, K., & van Ravenzwaaij, D. (2009). Individual differences in conflict-monitoring: Testing means and covariance hypothesis about the Simon and the Eriksen Flanker task. *Psychological Research*, *73*, 762–776. <http://dx.doi.org/10.1007/s00426-008-0188-9>
- Klauer, K. C., & Stegmaier, R. (1997). Interference in immediate spatial memory: Shifts of spatial attention or central-executive involvement?

- The Quarterly Journal of Experimental Psychology*, 50, 79–99. <http://dx.doi.org/10.1080/0272498973922233>
- Koch, I., Gade, M., Schuch, S., & Philipp, A. M. (2010). The role of inhibition in task switching: A review. *Psychonomic Bulletin & Review*, 17, 1–14. <http://dx.doi.org/10.3758/PBR.17.1.1>
- Kriegeskorte, N., & Kievit, R. A. (2013). Representational geometry: Integrating cognition, computation, and the brain. *Trends in Cognitive Sciences*, 17, 401–412. <http://dx.doi.org/10.1016/j.tics.2013.06.007>
- Kriegeskorte, N., Mur, M., & Bandettini, P. (2008). Representational similarity analysis - connecting the branches of systems neuroscience. *Frontiers in Systems Neuroscience*, 2, 4. <http://dx.doi.org/10.3389/neuro.06.004.2008>
- Lange, E. B., Cerella, J., & Verhaeghen, P. (2011). Ease of access to list items in short-term memory depends on the order of the recognition probes. *Journal of Experimental Psychology: Learning, Memory, and Cognition*, 37, 608–620. <http://dx.doi.org/10.1037/a0022220>
- Lange, E. B., & Oberauer, K. (2005). Overwriting of phonemic features in serial recall. *Memory*, 13, 333–339. <http://dx.doi.org/10.1080/09658210344000378>
- Lee, J. J., & Chabris, C. F. (2013). General cognitive ability and the psychophysical refractory period: Individual differences in the mind's bottleneck. *Psychological Science*, 24, 1226–1233. <http://dx.doi.org/10.1177/0956797612471540>
- Lepsien, J., & Nobre, A. C. (2006). Cognitive control of attention in the human brain: Insights from orienting attention to mental representations. *Brain Research*, 1105, 20–31. <http://dx.doi.org/10.1016/j.brainres.2006.03.033>
- Lewandowsky, S. (1999). Redintegration and response suppression in serial recall: A dynamic network model. *International Journal of Psychology (Special Issue: Short-Term/Working Memory)*, 34, 434–446.
- Lewandowsky, S., Duncan, M., & Brown, G. D. A. (2004). Time does not cause forgetting in short-term serial recall. *Psychonomic Bulletin & Review*, 11, 771–790. <http://dx.doi.org/10.3758/BF03196705>
- Lewandowsky, S., & Farrell, S. (2008a). Phonological similarity in serial recall: Constraints on theories of memory. *Journal of Memory and Language*, 58, 429–448. <http://dx.doi.org/10.1016/j.jml.2007.01.005>
- Lewandowsky, S., & Farrell, S. (2008b). Short-term memory: New data and a model. In B. H. Ross (Ed.), *The psychology of learning and motivation* (Vol. 49, pp. 1–48). London, United Kingdom: Elsevier. [http://dx.doi.org/10.1016/S0079-7421\(08\)00001-7](http://dx.doi.org/10.1016/S0079-7421(08)00001-7)
- Lewandowsky, S., & Farrell, S. (2011). *Computational modeling in cognition: Principles and practice*. Thousand Oaks, CA: Sage. <http://dx.doi.org/10.4135/9781483349428>
- Lewandowsky, S., Geiger, S. M., Morrell, D. B., & Oberauer, K. (2010). Turning simple span into complex span: Time for decay or interference from distractors? *Journal of Experimental Psychology: Learning, Memory, and Cognition*, 36, 958–978. <http://dx.doi.org/10.1037/a0019764>
- Lewandowsky, S., Geiger, S. M., & Oberauer, K. (2008). Interference-based forgetting in verbal short-term memory. *Journal of Memory and Language*, 59, 200–222. <http://dx.doi.org/10.1016/j.jml.2008.04.004>
- Lewandowsky, S., & Oberauer, K. (2008). The word-length effect provides no evidence for decay in short-term memory. *Psychonomic Bulletin & Review*, 15, 875–888. <http://dx.doi.org/10.3758/PBR.15.5.875>
- Lewis-Peacock, J. A., Drysdale, A. T., Oberauer, K., & Postle, B. R. (2012). Neural evidence for a distinction between short-term memory and the focus of attention. *Journal of Cognitive Neuroscience*, 24, 61–79. http://dx.doi.org/10.1162/jocn_a_00140
- Li, K. Z. H. (1999). Selection from working memory: On the relationship between processing and storage components. *Aging, Neuropsychology, and Cognition: A Journal on Normal and Dysfunctional Development*, 6, 99–116. <http://dx.doi.org/10.1076/anec.6.2.99.784>
- Lilienthal, L., Hale, S., & Myerson, J. (2014). The effects of environmental support and secondary tasks on visuospatial working memory. *Memory & Cognition*, 42, 1118–1129. <http://dx.doi.org/10.3758/s13421-014-0421-2>
- Loaiza, V. M., & McCabe, D. P. (2013). The influence of aging on attentional refreshing and articulatory rehearsal during working memory on later episodic memory performance. *Aging, Neuropsychology, and Cognition: A Journal on Normal and Dysfunctional Development*, 20, 471–493.
- Loaiza, V. M., & McCabe, D. P. (2012b). Temporal-contextual processing in working memory: Evidence from delayed cued recall and delayed free recall tests. *Memory & Cognition*, 40, 191–203. <http://dx.doi.org/10.3758/s13421-011-0148-2>
- Logie, R. H. (1995). *Visuo-spatial working memory*. Hove: Erlbaum.
- Logie, R. H. (2011). The functional organization and capacity limits of working memory. *Current Directions in Psychological Science*, 20, 240–245. <http://dx.doi.org/10.1177/0963721411415340>
- Longoni, A. M., Richardson, J. T. E., & Aiello, A. (1993). Articulatory rehearsal and phonological storage in working memory. *Memory & Cognition*, 21, 11–22. <http://dx.doi.org/10.3758/BF03211160>
- Lovatt, P., Avons, S. E., & Masterson, J. (2000). The word-length effect and disyllabic words. *The Quarterly Journal of Experimental Psychology*, 53, 1–22. <http://dx.doi.org/10.1080/713755877>
- Lovatt, P., Avons, S. E., & Masterson, J. (2002). Output decay in immediate serial recall: Speech time revisited. *Journal of Memory and Language*, 46, 227–243. <http://dx.doi.org/10.1006/jmla.2001.2806>
- Lovett, M. C., Reder, L. M., & Lebiere, C. (1999). Modeling working memory in a unified architecture: An ACT-R perspective. In A. Miyake & P. Shah (Eds.), *Models of working memory. Mechanisms of active maintenance and executive control* (pp. 135–182). Cambridge: Cambridge University Press. <http://dx.doi.org/10.1017/CBO9781139174909.008>
- Luck, S. J., & Vogel, E. K. (1997). The capacity of visual working memory for features and conjunctions. *Nature*, 390, 279–281. <http://dx.doi.org/10.1038/36846>
- Luck, S. J., & Vogel, E. K. (2013). Visual working memory capacity: From psychophysics and neurobiology to individual differences. *Trends in Cognitive Sciences*, 17, 391–400. <http://dx.doi.org/10.1016/j.tics.2013.06.006>
- Ma, W. J., Husain, M., & Bays, P. M. (2014). Changing concepts of working memory. *Nature Neuroscience*, 17, 347–356. <http://dx.doi.org/10.1038/nn.3655>
- Macken, W. J., & Jones, D. M. (1995). Functional characteristics of the inner voice and the inner ear: Single or double agency? *Journal of Experimental Psychology: Learning, Memory, and Cognition*, 21, 436–448. <http://dx.doi.org/10.1037/0278-7393.21.2.436>
- Magnussen, S., & Greenlee, M. W. (1999). The psychophysics of perceptual memory. *Psychological Research*, 62, 81–92. <http://dx.doi.org/10.1007/s004260050043>
- Makovski, T. (2012). Are multiple visual short-term memory storages necessary to explain the retro-cue effect? *Psychonomic Bulletin & Review*, 19, 470–476. <http://dx.doi.org/10.3758/s13423-012-0235-9>
- Makovski, T., Shim, W. M., & Jiang, Y. V. (2006). Interference from filled delays on visual change detection. *Journal of Vision*, 6, 1459–1470. <http://dx.doi.org/10.1167/6.12.11>
- Mall, J. T., Morey, C. C., Wolff, M. J., & Lehnert, F. (2014). Visual selective attention is equally functional for individuals with low and high working memory capacity: Evidence from accuracy and eye movements. *Attention, Perception, & Psychophysics*, 76, 1998–2014. <http://dx.doi.org/10.3758/s13414-013-0610-2>
- Matthey, L., Bays, P. M., & Dayan, P. (2015). A probabilistic palimpsest model of visual short-term memory. *PLoS Computational Biology*, 11. <http://dx.doi.org/10.1371/journal.pcbi.1004003>
- Maylor, E. A., Vousden, J. I., & Brown, G. D. A. (1999). Adult age differences in short-term memory for serial order: Data and a model.

- Psychology and Aging*, 14, 572–594. <http://dx.doi.org/10.1037/0882-7974.14.4.572>
- Mayr, U., & Keele, S. W. (2000). Changing internal constraints on action: The role of backward inhibition. *Journal of Experimental Psychology: General*, 129, 4–26. <http://dx.doi.org/10.1037/0096-3445.129.1.4>
- McCormack, T., Brown, G. D. A., Vousden, J. I., & Henson, R. N. A. (2000). Children's serial recall errors: Implications for theories of short-term memory development. *Journal of Experimental Child Psychology*, 76, 222–252. <http://dx.doi.org/10.1006/jecp.1999.2550>
- McElree, B. (2006). Accessing recent events. In B. H. Ross (Ed.), *The psychology of learning and motivation* (Vol. 46, pp. 155–200). San Diego, CA: Academic Press.
- McFarlane, K. A., & Humphreys, M. S. (2012). Maintenance rehearsal: The key to the role attention plays in storage and forgetting. *Journal of Experimental Psychology: Learning, Memory, and Cognition*, 38, 1001–1018. <http://dx.doi.org/10.1037/a0026783>
- McVay, J. C., & Kane, M. J. (2009). Conducting the train of thought: Working memory capacity, goal neglect, and mind wandering in an executive-control task. *Journal of Experimental Psychology: Learning, Memory, and Cognition*, 35, 196–204. <http://dx.doi.org/10.1037/a0014104>
- McVay, J. C., & Kane, M. J. (2012). Why does working memory capacity predict variation in reading comprehension? On the influence of mind wandering and executive attention. *Journal of Experimental Psychology: General*, 141, 302–320. <http://dx.doi.org/10.1037/a0025250>
- Meier, M. E., & Kane, M. J. (2013). Working memory capacity and Stroop interference: Global versus local indices of executive control. *Journal of Experimental Psychology: Learning, Memory, and Cognition*, 39, 748–759. <http://dx.doi.org/10.1037/a0029200>
- Mercer, T. (2014). The loss of short-term visual representations over time: Decay or temporal distinctiveness? *Journal of Experimental Psychology: Human Perception and Performance*, 40, 2281–2288. <http://dx.doi.org/10.1037/a0038141>
- Mercer, T., & Duffy, P. (2015). The loss of residual visual memories over the passage of time. *The Quarterly Journal of Experimental Psychology: Human Experimental Psychology*, 68, 242–248. <http://dx.doi.org/10.1080/17470218.2014.975256>
- Mercer, T., & McKeown, D. (2010). Updating and feature overwriting in short-term memory for timbre. *Attention, Perception, & Psychophysics*, 72, 2289–2303. <http://dx.doi.org/10.3758/BF03196702>
- Mercer, T., & McKeown, D. (2014). Decay uncovered in nonverbal short-term memory. *Psychonomic Bulletin & Review*, 21, 128–135. <http://dx.doi.org/10.3758/s13423-013-0472-6>
- Miller, G. A. (1956). The magical number seven plus or minus two: Some limits on our capacity for processing information. *Psychological Review*, 63, 81–97. <http://dx.doi.org/10.1037/h0043158>
- Monsell, S., Sumner, P., & Waters, H. (2003). Task-set reconfiguration with predictable and unpredictable task switches. *Memory & Cognition*, 31, 327–342. <http://dx.doi.org/10.3758/BF03194391>
- Morey, C. C., & Bieler, M. (2013). Visual short-term memory always requires general attention. *Psychonomic Bulletin & Review*, 20, 163–170. <http://dx.doi.org/10.3758/s13423-012-0313-z>
- Morey, C. C., & Cowan, N. (2004). When visual and verbal memories compete: Evidence of cross-domain limits in working memory. *Psychonomic Bulletin & Review*, 11, 296–301. <http://dx.doi.org/10.3758/BF03196573>
- Mueller, S. T., Seymour, T. L., Kieras, D. E., & Meyer, D. E. (2003). Theoretical implications of articulatory duration, phonological similarity, and phonological complexity in verbal working memory. *Journal of Experimental Psychology: Learning, Memory, and Cognition*, 29, 1353–1380. <http://dx.doi.org/10.1037/0278-7393.29.6.1353>
- Nairne, J. S. (1990). A feature model of immediate memory. *Memory & Cognition*, 18, 251–269. <http://dx.doi.org/10.3758/BF03213879>
- Navon, D. (1984). Resources - a theoretical soupstone? *Psychological Review*, 91, 216–234. <http://dx.doi.org/10.1037/0033-295X.91.2.216>
- Navon, D., & Gopher, D. (1979). On the economy of the human-processing system. *Psychological Review*, 86, 214–255. <http://dx.doi.org/10.1037/0033-295X.86.3.214>
- Navon, D., & Miller, J. (2002). Queuing or sharing? A critical evaluation of the single-bottleneck notion. *Cognitive Psychology*, 44, 193–251. <http://dx.doi.org/10.1006/cogp.2001.0767>
- Newell, A. (1973). You can't play twenty questions with nature and win. In W. G. Chase (Ed.), *Visual information processing* (pp. 283–308). New York, NY: Academic Press.
- Nieuwenstein, M., & Wyble, B. (2014). Beyond a mask and against the bottleneck: Retroactive dual-task interference during working memory consolidation of a masked visual target. *Journal of Experimental Psychology: General*, 143, 1409–1427. <http://dx.doi.org/10.1037/a0035257>
- Nipher, F. E. (1878). On the distribution of errors in numbers written from memory. *Transactions of the Academy of Science of St. Louis*, 3, CCX–CCXI.
- Norman, D. A., & Bobrow, D. G. (1975). On data-limited and resource-limited processes. *Cognitive Psychology*, 7, 44–64. [http://dx.doi.org/10.1016/0010-0285\(75\)90004-3](http://dx.doi.org/10.1016/0010-0285(75)90004-3)
- Nuerk, H. C., Wood, G., & Willmes, K. (2005). The universal SNARC effect: The association between number magnitude and space is amodal. *Experimental Psychology*, 52, 187–194. <http://dx.doi.org/10.1027/1618-3169.52.3.187>
- Oberauer, K. (2009). Design for a working memory. *Psychology of Learning and Motivation: Advances in Research and Theory*, 51, 45–100. [http://dx.doi.org/10.1016/S0079-7421\(09\)51002-X](http://dx.doi.org/10.1016/S0079-7421(09)51002-X)
- Oberauer, K., & Eichenberger, S. (2013). Visual working memory declines when more features must be remembered for each object. *Memory & Cognition*, 41, 1212–1227. <http://dx.doi.org/10.3758/s13421-013-0333-6>
- Oberauer, K., Farrell, S., Jarrold, C., Pasiecznik, K., & Greaves, M. (2012). Interference between maintenance and processing in working memory: The effect of item-distractor similarity in complex span. *Journal of Experimental Psychology: Learning, Memory, and Cognition*, 38, 665–685. <http://dx.doi.org/10.1037/a0026337>
- Oberauer, K., & Hein, L. (2012). Attention to information in working memory. *Current Directions in Psychological Science*, 21, 164–169. <http://dx.doi.org/10.1177/0963721412444727>
- Oberauer, K., & Kliegl, R. (2001). Beyond resources: Formal models of complexity effects and age differences in working memory. *European Journal of Cognitive Psychology*, 13, 187–215. <http://dx.doi.org/10.1080/09541440042000278>
- Oberauer, K., & Kliegl, R. (2006). A formal model of capacity limits in working memory. *Journal of Memory and Language*, 55, 601–626. <http://dx.doi.org/10.1016/j.jml.2006.08.009>
- Oberauer, K., & Lange, E. B. (2008). Interference in verbal working memory: Distinguishing similarity-based confusion, feature overwriting, and feature migration. *Journal of Memory and Language*, 58, 730–745. <http://dx.doi.org/10.1016/j.jml.2007.09.006>
- Oberauer, K., & Lewandowsky, S. (2008). Forgetting in immediate serial recall: Decay, temporal distinctiveness, or interference? *Psychological Review*, 115, 544–576. <http://dx.doi.org/10.1037/0033-295X.115.3.544>
- Oberauer, K., & Lewandowsky, S. (2011). Modeling working memory: A computational implementation of the Time-Based Resource-Sharing theory. *Psychonomic Bulletin & Review*, 18, 10–45. <http://dx.doi.org/10.3758/s13423-010-0020-6>
- Oberauer, K., & Lewandowsky, S. (2013). Evidence against decay in verbal working memory. *Journal of Experimental Psychology: General*, 142, 380–411. <http://dx.doi.org/10.1037/a0029588>
- Oberauer, K., & Lewandowsky, S. (2014). Further evidence against decay in working memory. *Journal of Memory and Language*, 73, 15–30. <http://dx.doi.org/10.1016/j.jml.2014.02.003>

- Oberauer, K., Lewandowsky, S., Farrell, S., Jarrold, C., & Greaves, M. (2012). Modeling working memory: An interference model of complex span. *Psychonomic Bulletin & Review*, *19*, 779–819. <http://dx.doi.org/10.3758/s13423-012-0272-4>
- Oberauer, K., Souza, A. S., Druey, M. D., & Gade, M. (2013). Analogous mechanisms of selection and updating in declarative and procedural working memory: Experiments and a computational model. *Cognitive Psychology*, *66*, 157–211. <http://dx.doi.org/10.1016/j.cogpsych.2012.11.001>
- Oberauer, K., Süß, H.-M., Schulze, R., Wilhelm, O., & Wittmann, W. W. (2000). Working memory capacity - facets of a cognitive ability construct. *Personality and Individual Differences*, *29*, 1017–1045. [http://dx.doi.org/10.1016/S0191-8869\(99\)00251-2](http://dx.doi.org/10.1016/S0191-8869(99)00251-2)
- Oberauer, K., Süß, H.-M., Wilhelm, O., & Sander, N. (2007). Individual differences in working memory capacity and reasoning ability. In A. R. A. Conway, C. Jarrold, M. J. Kane, A. Miyake, & J. N. Towse (Eds.), *Variation in working memory* (pp. 49–75). New York, NY: Oxford University Press.
- Oberauer, K., Süß, H.-M., Wilhelm, O., & Wittmann, W. W. (2003). The multiple faces of working memory - storage, processing, supervision, and coordination. *Intelligence*, *31*, 167–193. [http://dx.doi.org/10.1016/S0160-2896\(02\)00115-0](http://dx.doi.org/10.1016/S0160-2896(02)00115-0)
- Oberauer, K., Süß, H.-M., Wilhelm, O., & Wittmann, W. W. (2008). Which working memory functions predict intelligence? *Intelligence*, *36*, 641–652. <http://dx.doi.org/10.1016/j.intell.2008.01.007>
- Olson, I. R., & Jiang, Y. (2002). Is visual short-term memory object based? Rejection of the “strong-object” hypothesis. *Perception & Psychophysics*, *64*, 1055–1067. <http://dx.doi.org/10.3758/BF03194756>
- Page, M. P. A., & Norris, D. (1998). The primacy model: A new model of immediate serial recall. *Psychological Review*, *105*, 761–781. <http://dx.doi.org/10.1037/0033-295X.105.4.761-781>
- Park, D. C., Lautenschlager, G., Hedden, T., Davidson, N. S., Smith, A. D., & Smith, P. K. (2002). Models of visuospatial and verbal memory across the adult life span. *Psychology and Aging*, *17*, 299–320. <http://dx.doi.org/10.1037/0882-7974.17.2.299>
- Parmentier, F. B. R. (2011). Exploring the determinants of memory for spatial sequences. In A. Vandierendonck & A. Szmalec (Eds.), *Spatial working memory* (pp. 68–86). Hove: Psychology Press.
- Parmentier, F. B. R., Elford, G., & Maybery, M. (2005). Transitional information in spatial serial memory: Path characteristics affect recall performance. *Journal of Experimental Psychology: Learning, Memory, and Cognition*, *31*, 412–427. <http://dx.doi.org/10.1037/0278-7393.31.3.412>
- Parmentier, F. B. R., & Jones, D. M. (2000). Functional characteristics of auditory temporal-spatial short-term memory: Evidence from serial order errors. *Journal of Experimental Psychology: Learning, Memory, and Cognition*, *26*, 222–238. <http://dx.doi.org/10.1037/0278-7393.26.1.222>
- Pashler, H. (1994). Dual-task interference in simple tasks: Data and theory. *Psychological Bulletin*, *116*, 220–244. <http://dx.doi.org/10.1037/0033-2909.116.2.220>
- Pearson, D., & Sahraie, A. (2003). Oculomotor control and the maintenance of spatially and temporally distributed events in visuo-spatial working memory. *The Quarterly Journal of Experimental Psychology*, *56*, 1089–1111. <http://dx.doi.org/10.1080/02724980343000044>
- Penney, C. G. (1975). Modality effects in short-term verbal memory. *Psychological Bulletin*, *82*, 68–84. <http://dx.doi.org/10.1037/h0076166>
- Pertsov, Y., Bays, P. M., Joseph, S., & Husain, M. (2013). Rapid forgetting prevented by retrospective attention cues. *Journal of Experimental Psychology: Human Perception and Performance*, *39*, 1224–1231. <http://dx.doi.org/10.1037/a0030947>
- Peterson, L. R., & Peterson, M. J. (1959). Short-term retention of individual verbal items. *Journal of Experimental Psychology*, *58*, 193–198. <http://dx.doi.org/10.1037/h0049234>
- Phaf, R. H., & Wolters, G. (1993). Attentional shifts in maintenance rehearsal. *The American Journal of Psychology*, *106*, 353–382. <http://dx.doi.org/10.2307/1423182>
- Phillips, W. A., & Christie, D. F. M. (1977). Components of visual memory. *The Quarterly Journal of Experimental Psychology*, *29*, 117–133. <http://dx.doi.org/10.1080/00335557743000080>
- Ploner, C. J., Gaymard, B., Rivaud, S., Agid, Y., & Pierrot-Deseilligny, C. (1998). Temporal limits of spatial working memory in humans. *European Journal of Neuroscience*, *10*, 794–797. <http://dx.doi.org/10.1046/j.1460-9568.1998.00101.x>
- Poirier, M., Saint-Aubin, J., Musselwhite, K., Mohanadas, T., & Mahammed, G. (2007). Visual similarity effects on short-term memory for order: The case of verbally labeled pictorial stimuli. *Memory & Cognition*, *35*, 711–723. <http://dx.doi.org/10.3758/BF03193309>
- Ratcliff, R. (1978). A theory of memory retrieval. *Psychological Review*, *85*, 59–108. <http://dx.doi.org/10.1037/0033-295X.85.2.59>
- Ratcliff, R., Thapar, A., & McKoon, G. (2010). Individual differences, aging, and IQ in two-choice tasks. *Cognitive Psychology*, *60*, 127–157. <http://dx.doi.org/10.1016/j.cogpsych.2009.09.001>
- Raye, C. L., Johnson, M. K., Mitchell, K. J., Greene, E. J., & Johnson, M. R. (2007). Refreshing: A minimal executive function. *Cortex*, *43*, 135–145. [http://dx.doi.org/10.1016/S0010-9452\(08\)70451-9](http://dx.doi.org/10.1016/S0010-9452(08)70451-9)
- Ricker, T. J., & Cowan, N. (2010). Loss of visual working memory within seconds: The combined use of refreshable and non-refreshable features. *Journal of Experimental Psychology: Learning, Memory, and Cognition*, *36*, 1355–1368. <http://dx.doi.org/10.1037/a0020356>
- Ricker, T. J., & Cowan, N. (2014). Differences between presentation methods in working memory procedures: A matter of working memory consolidation. *Journal of Experimental Psychology: Learning, Memory, and Cognition*, *40*, 417–428. <http://dx.doi.org/10.1037/a0034301>
- Ricker, T. J., Spiegel, L. R., & Cowan, N. (2014). Time-based loss in visual short-term memory is from trace decay, not temporal distinctiveness. *Journal of Experimental Psychology: Learning, Memory, and Cognition*, *40*, 1510–1523. <http://dx.doi.org/10.1037/xlm0000018>
- Rogers, R. D., & Monsell, S. (1995). Costs of a predictable switch between simple cognitive tasks. *Journal of Experimental Psychology: General*, *124*, 207–231. <http://dx.doi.org/10.1037/0096-3445.124.2.207>
- Rohrer, D., & Pashler, H. E. (2003). Concurrent task effects on memory retrieval. *Psychonomic Bulletin & Review*, *10*, 96–103. <http://dx.doi.org/10.3758/BF03196472>
- Saito, S., & Miyake, A. (2004). On the nature of forgetting and the processing-storage relationship in reading span performance. *Journal of Memory and Language*, *50*, 425–443. <http://dx.doi.org/10.1016/j.jml.2003.12.003>
- Sakai, K., & Inui, T. (2002). A feature-segmentation model of short-term visual memory. *Perception*, *31*, 579–589. <http://dx.doi.org/10.1068/p3320>
- Salthouse, T. A. (1994). How many causes are there of aging-related decrements in cognitive functioning? *Developmental Review*, *14*, 413–437. <http://dx.doi.org/10.1006/drev.1994.1016>
- Salthouse, T. A. (1996). The processing-speed theory of adult age differences in cognition. *Psychological Review*, *103*, 403–428. <http://dx.doi.org/10.1037/0033-295X.103.3.403>
- Sanders, A. F., & Schroots, J. J. F. (1969). Cognitive categories and memory span III. Effects of similarity on recall. *The Quarterly Journal of Experimental Psychology*, *21*, 21–28. <http://dx.doi.org/10.1080/14640746908400190>
- Saults, J. S., & Cowan, N. (2007). A central capacity limit to the simultaneous storage of visual and auditory arrays in working memory. *Journal of Experimental Psychology: General*, *136*, 663–684. <http://dx.doi.org/10.1037/0096-3445.136.4.663>
- Schmiedek, F., Oberauer, K., Wilhelm, O., Süß, H. M., & Wittmann, W. W. (2007). Individual differences in components of reaction time distributions and their relations to working memory and intelligence.

- Journal of Experimental Psychology: General*, 136, 414–429. <http://dx.doi.org/10.1037/0096-3445.136.3.414>
- Schweickert, R. (1993). A multinomial processing tree model for degradation and redintegration in immediate recall. *Memory & Cognition*, 21, 168–175. <http://dx.doi.org/10.3758/BF03202729>
- Schweickert, R., & Boruff, B. (1986). Short-term memory capacity: Magic number or magic spell? *Journal of Experimental Psychology: Learning, Memory, and Cognition*, 12, 419–425. <http://dx.doi.org/10.1037/0278-7393.12.3.419>
- Sederberg, P. B., Howard, M. W., & Kahana, M. J. (2008). A context-based theory of recency and contiguity in free recall. *Psychological Review*, 115, 893–912. <http://dx.doi.org/10.1037/a0013396>
- Service, E. (1998). The effect of word length on immediate serial recall depends on phonological complexity, not articulatory duration. *The Quarterly Journal of Experimental Psychology*, 51A, 283–304. <http://dx.doi.org/10.1080/713755759>
- Sewell, D. K., Lilburn, S. D., & Smith, P. L. (2014). An information capacity limitation of visual short-term memory. *Journal of Experimental Psychology: Human Perception and Performance*, 40, 2214–2242. <http://dx.doi.org/10.1037/a0037744>
- Shah, P., & Miyake, A. (1996). The separability of working memory resources for spatial thinking and language processing: An individual differences approach. *Journal of Experimental Psychology: General*, 125, 4–27. <http://dx.doi.org/10.1037/0096-3445.125.1.4>
- Shipstead, Z., & Engle, R. E. (2013). Interference within the focus of attention: Working memory tasks reflect more than temporary maintenance. *Journal of Experimental Psychology: Learning, Memory, and Cognition*, 39, 277–289. <http://dx.doi.org/10.1037/a0028467>
- Shipstead, Z., Lindsey, D. R. B., Marshall, R. L., & Engle, R. E. (2014). The mechanisms of working memory capacity: Primary memory, secondary memory, and attention control. *Journal of Memory and Language*, 72, 116–141. <http://dx.doi.org/10.1016/j.jml.2014.01.004>
- Sigman, M., & Dehaene, S. (2005). Parsing a cognitive task: A characterization of the mind's bottleneck. *PLoS Biology*, 3, e37. <http://dx.doi.org/10.1371/journal.pbio.0030037>
- Sigman, M., & Dehaene, S. (2006). Dynamics of the central bottleneck: Dual-task and task uncertainty. *PLoS Biology*, 4, e220.
- Smyth, M. M., & Scholey, K. A. (1994). Characteristics of spatial memory span: Is there an analogy to the word length effect, based on movement time? *The Quarterly Journal of Experimental Psychology*, 47, 91–117. <http://dx.doi.org/10.1080/14640749408401145>
- Sobel, K. V., Gerrie, M. P., Poole, B. J., & Kane, M. J. (2007). Individual differences in working memory capacity and visual search: The roles of top-down and bottom-up processing. *Psychonomic Bulletin & Review*, 14, 840–845. <http://dx.doi.org/10.3758/BF03194109>
- Souza, A. S., & Oberauer, K. (2015). Time-based forgetting in visual working memory reflects temporal distinctiveness, not decay. *Psychonomic Bulletin & Review*, 22, 156–162. <http://dx.doi.org/10.3758/s13423-014-0652-z>
- Souza, A. S., Rerko, L., & Oberauer, K. (2014). Unloading and reloading working memory: Attending to one item frees capacity. *Journal of Experimental Psychology: Human Perception and Performance*, 40, 1237–1256. <http://dx.doi.org/10.1037/a0036331>
- Stahl, C., Voss, A., Schmitz, F., Nuszbaum, M., Tüscher, O., Lieb, K., & Klauer, K. C. (2014). Behavioral components of impulsivity. *Journal of Experimental Psychology: General*, 143, 850–886. <http://dx.doi.org/10.1037/a0033981>
- Sternberg, S. (1966). High-speed scanning in human memory. *Science*, 153, 652–654. <http://dx.doi.org/10.1126/science.153.3736.652>
- Tan, L., & Ward, G. (2008). Rehearsal in immediate serial recall. *Psychonomic Bulletin & Review*, 15, 535–542. <http://dx.doi.org/10.3758/PBR.15.3.535>
- Teasdale, J. D., Proctor, L., Lloyd, C. A., & Baddeley, A. D. (1993). Working memory and stimulus-independent thought: Effects of memory load and presentation rate. *European Journal of Cognitive Psychology*, 5, 417–433. <http://dx.doi.org/10.1080/09541449308520128>
- Tehan, G., Fogarty, G., & Ryan, K. (2004). The contribution to immediate serial recall of rehearsal, search speed, access to lexical memory, and phonological coding: An investigation at the construct level. *Memory & Cognition*, 32, 711–721. <http://dx.doi.org/10.3758/BF03195861>
- Tehan, G., & Lalor, D. M. (2000). Individual differences in memory span: The contribution of rehearsal, access to lexical memory, and output speed. *The Quarterly Journal of Experimental Psychology*, 53, 1012–1038. <http://dx.doi.org/10.1080/713755933>
- Tombu, M., & Jolicoeur, P. (2003). A central capacity sharing model of dual-task performance. *Journal of Experimental Psychology: Human Perception and Performance*, 29, 3–18. <http://dx.doi.org/10.1037/0096-1523.29.1.3>
- Towse, J. N., & Hitch, G. J. (1995). Is there a relationship between task demand and storage space in tests of working memory capacity? *The Quarterly Journal of Experimental Psychology*, 48, 108–124. <http://dx.doi.org/10.1080/14640749508401379>
- Towse, J. N., Hitch, G. J., & Hutton, U. (2000). On the interpretation of working memory span in adults. *Memory & Cognition*, 28, 341–348. <http://dx.doi.org/10.3758/BF03198549>
- Towse, J. N., & Houston-Price, C. M. T. (2001). Combining representations in working memory: A brief report. *British Journal of Developmental Psychology*, 19, 319–324. <http://dx.doi.org/10.1348/026151001166100>
- Tsubomi, H., Fukuda, K., Watanabe, K., & Vogel, E. K. (2013). Neural limits to representing objects still within view. *The Journal of Neuroscience*, 33, 8257–8263. <http://dx.doi.org/10.1523/JNEUROSCI.5348-12.2013>
- Turner, M. L., & Engle, R. W. (1989). Is working memory capacity task dependent? *Journal of Memory and Language*, 28, 127–154. [http://dx.doi.org/10.1016/0749-596X\(89\)90040-5](http://dx.doi.org/10.1016/0749-596X(89)90040-5)
- Underwood, B. J. (1975). Individual differences as a crucible in theory construction. *American Psychologist*, 30, 128–134. <http://dx.doi.org/10.1037/h0076759>
- Unsworth, N. (2010). On the division of working memory and long-term memory and their relation to intelligence: A latent variable approach. *Acta Psychologica*, 134, 16–28. <http://dx.doi.org/10.1016/j.actpsy.2009.11.010>
- Unsworth, N., Brewer, G. A., & Spillers, G. J. (2009). There's more to the working memory capacity-fluid intelligence relationship than just secondary memory. *Psychonomic Bulletin & Review*, 16, 931–937. <http://dx.doi.org/10.3758/PBR.16.5.931>
- Unsworth, N., & Engle, R. W. (2007). The nature of individual differences in working memory capacity: Active maintenance in primary memory and controlled search from secondary memory. *Psychological Review*, 114, 104–132. <http://dx.doi.org/10.1037/0033-295X.114.1.104>
- Unsworth, N., Fukuda, K., Awh, E., & Vogel, E. K. (2014). Working memory and fluid intelligence: Capacity, attention control, and secondary memory retrieval. *Cognitive Psychology*, 71, 1–26. <http://dx.doi.org/10.1016/j.cogpsych.2014.01.003>
- Unsworth, N., Schrock, J. C., & Engle, R. W. (2004). Working memory capacity and the antisaccade task: Individual differences in voluntary saccade control. *Journal of Experimental Psychology: Learning, Memory, and Cognition*, 30, 1302–1321. <http://dx.doi.org/10.1037/0278-7393.30.6.1302>
- Vallar, G., & Baddeley, A. D. (1982). Short-term forgetting and the articulatory loop. *The Quarterly Journal of Experimental Psychology Section A: Human Experimental Psychology*, 34, 53–60. <http://dx.doi.org/10.1080/14640748208400857>
- van den Berg, R., Awh, E., & Ma, W. J. (2014). Factorial comparison of working memory models. *Psychological Review*, 121, 124–149. <http://dx.doi.org/10.1037/a0035234>

- Vergauwe, E., Barrouillet, P., & Camos, V. (2010). Do mental processes share a domain-general resource? *Psychological Science*, *21*, 384–390. <http://dx.doi.org/10.1177/0956797610361340>
- Vergauwe, E., Camos, V., & Barrouillet, P. (2014). The impact of storage on processing: How is information maintained in working memory? *Journal of Experimental Psychology: Learning, Memory, and Cognition*, *40*, 1072–1095. <http://dx.doi.org/10.1037/a0035779>
- Vergauwe, E., Dewaele, N., Langerock, N., & Barrouillet, P. (2012). Evidence for a central pool of general resources in working memory. *Journal of Cognitive Psychology*, *24*, 359–366. <http://dx.doi.org/10.1080/20445911.2011.640625>
- Vogel, E. K., McCollough, A. W., & Machizawa, M. G. (2005). Neural measures reveal individual differences in controlling access to working memory. *Nature*, *438*, 500–503. <http://dx.doi.org/10.1038/nature04171>
- Vogel, E. K., Woodman, G. F., & Luck, S. J. (2001). Storage of features, conjunctions and objects in visual working memory. *Journal of Experimental Psychology: Human Perception and Performance*, *27*, 92–114. <http://dx.doi.org/10.1037/0096-1523.27.1.92>
- Vogel, E. K., Woodman, G. F., & Luck, S. J. (2006). The time course of consolidation in visual working memory. *Journal of Experimental Psychology: Human Perception and Performance*, *32*, 1436–1451. <http://dx.doi.org/10.1037/0096-1523.32.6.1436>
- Walsh, V. (2003). A theory of magnitude: Common cortical metrics of time, space and quantity. *Trends in Cognitive Sciences*, *7*, 483–488. <http://dx.doi.org/10.1016/j.tics.2003.09.002>
- Wilhelm, O., Hildebrandt, A., & Oberauer, K. (2013). What is working memory capacity, and how can we measure it? *Frontiers in Psychology*, *4*, 433. <http://dx.doi.org/10.3389/fpsyg.2013.00433>
- Williams, M., Hong, S. W., Kang, M.-S., Carlisle, N. B., & Woodman, G. F. (2013). The benefit of forgetting. *Psychonomic Bulletin & Review*, *20*, 348–355. <http://dx.doi.org/10.3758/s13423-012-0354-3>
- Zhang, W., & Luck, S. J. (2008). Discrete fixed-resolution representations in visual working memory. *Nature*, *453*, 233–235. <http://dx.doi.org/10.1038/nature06860>
- Zhang, W., & Luck, S. J. (2009). Sudden death and gradual decay in visual working memory. *Psychological Science*, *20*, 423–428. <http://dx.doi.org/10.1111/j.1467-9280.2009.02322.x>

Received November 24, 2014

Revision received December 14, 2015

Accepted December 15, 2015 ■

ORDER FORM

Start my 2016 subscription to *Psychological Bulletin*®
ISSN: 0033-2909

___ \$160.00 **APA MEMBER/AFFILIATE** _____

___ \$290.00 **INDIVIDUAL NONMEMBER** _____

___ \$1,199.00 **INSTITUTION** _____

Sales Tax: 5.75% in DC and 6% in MD _____

TOTAL AMOUNT DUE \$ _____

Subscription orders must be prepaid. Subscriptions are on a calendar year basis only. Allow 4-6 weeks for delivery of the first issue. Call for international subscription rates.



AMERICAN
PSYCHOLOGICAL
ASSOCIATION

SEND THIS ORDER FORM TO
American Psychological Association
Subscriptions
750 First Street, NE
Washington, DC 20002-4242

Call **800-374-2721** or 202-336-5600
Fax **202-336-5568** :TDD/TTY **202-336-6123**
For subscription information,
e-mail: subscriptions@apa.org

Check enclosed (make payable to APA)

Charge my: Visa MasterCard American Express

Cardholder Name _____

Card No. _____ Exp. Date _____

Signature (Required for Charge)

Billing Address

Street _____

City _____ State _____ Zip _____

Daytime Phone _____

E-mail _____

Mail To

Name _____

Address _____

City _____ State _____ Zip _____

APA Member # _____

BULA16